

TOSHIBA



DVD VIDEO PLAYER

SD-6980SY

OWNER'S MANUAL

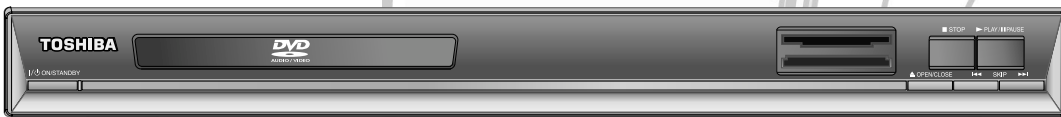

Introduction

Safety Precautions



TO REDUCE THE RISK OF ELECTRIC SHOCK, DO NOT REMOVE THE COVER(OR BACK). NO USER-SERVICEABLE PARTS ARE INSIDE. REFER SERVICING TO QUALIFIED SERVICE PERSONNEL.



This lightning flash with arrowhead symbol within an equilateral triangle is intended to alert the user to the presence of uninsulated dangerous voltage within the product's enclosure that may be of sufficient magnitude to constitute a risk of electric shock to persons.



The exclamation point within an equilateral triangle is intended to alert the user to the presence of important operating and maintenance (servicing) instructions in the literature accompanying the product.

WARNING : Do not install this equipment in a confined space such as a bookcase or similar unit.

WARNING : TO REDUCE THE RISK OF FIRE OR ELECTRIC SHOCK, DO NOT EXPOSE THIS APPARATUS TO RAIN OR MOISTURE.

CAUTION : DVD PLAYERS USE AN INVISIBLE LASER BEAM WHICH CAN CAUSE HAZARDOUS RADIATION EXPOSURE IF DIRECTED. BE SURE TO OPERATE PLAYER CORRECTLY AS INSTRUCTED.

CAUTIONS

Caution: To prevent electric shock, match wide blade of plug to wide slot, fully insert.

Attention: Pour éviter les chocs électriques, introduire la lame la plus large de la fiche dans la borne correspondante de la prise et pousser jusqu'au fond.

CAUTION : This DVD player employs a Laser System. To ensure proper use of this product, please read this owner's manual carefully and retain for future reference. Should the unit require maintenance, contact an authorized Service location. Use of controls, adjustments, or the performance of procedures other than those specified herein may result in hazardous radiation exposure.

To prevent direct exposure to laser beam, do not try to open the enclosure. Visible laser radiation when open. DO NOT STARE INTO BEAM.

CLASS 1 LASER PRODUCT
 KLASSE 1 LASER PRODUKT
 LUOKAN 1 LASER LAITE
 KLASS 1 LASER APPARAT
 PRODUCTO LÁSER CLASE 1

CAUTION: The apparatus should not be exposed to water (dripping or splashing) and no objects filled with liquids, such as vases, should be placed on the apparatus.

SERIAL NUMBER: The serial number is found on the back of this unit. This number is unique to this unit and not available to others. You should record requested information here and retain this guide as a permanent record of your purchase.

Model No. _____

Serial No. _____

Introduction

Important Safety Instructions

- 1) Read these instructions.
- 2) Keep these instructions.
- 3) Heed all warnings.
- 4) Follow all instructions.
- 5) Do not use this apparatus near water.
- 6) Clean only with dry cloth.
- 7) Do not block any ventilation openings, Install in accordance with the manufacturer's instructions.
- 8) Do not install near any heat sources such as radiators, heat registers, or other apparatus (including amplifiers) that produce heat.
- 9) Protect the power cord from being walked on or pinched particularly at plugs, convenience receptacles, and the point where they exit from the apparatus.
- 10) Only use attachments/accessories specified by the manufacturer.
- 11) Use only with the cart, stand, tripod, bracket, or table specified by the manufacturer, or sold with the apparatus. When a cart is used, use caution when moving the cart/apparatus combination to avoid injury from tip-over.
- 12) Unplug this apparatus during lightning storms or when unused for long periods of time.
- 13) Refer all servicing to qualified service personnel. Servicing is required when the apparatus has been damaged in any way, such as power-supply cord or plug is damaged, liquid has been spilled or objects have fallen into the apparatus the apparatus has been exposed to rain or moisture, does not operate normally, or has been dropped.
- 14) When you use headphones on the amplifier, keep the volume at a moderate level.
If you use the headphones continuously with high volume sound, it may cause hearing damage.
- 15) Do not overload wall outlets; extension cords, or integral convenience receptacles as this can result in a risk of fire or electric shock.
- 16) Never insert objects of any kind into this apparatus through openings as they may touch dangerous voltage points or short-out parts that could result in a fire or electric shock. Never spill liquid of any kind on the apparatus.
- 17) Keep your fingers well clear of the disc tray as it is closing. Neglecting to do so may cause serious personal injury.
- 18) Do not place a heavy object on or step on the apparatus. The object may fall, causing serious personal injury and serious damage to the apparatus.
- 19) Do not use a cracked, deformed, or repaired disc. These discs are easily broken and may cause serious personal injury and apparatus malfunction.



Introduction

Note:

- This unit can be used only where the power supply is AC 110~240V, 60/50Hz. It cannot be used elsewhere.

Notes on Regional Codes

- Most DVD discs have a globe with one or more numbers in it clearly visible on the cover. This number must match your DVD player's regional code or the disc cannot play.
- If you try to play a DVD with a different region code from your player, the message "Check Regional Code" appears on the TV screen.

Notes on DVDs and Video CDs

Because of problems and errors that can occur during the creation of DVD and CD software and/or the manufacture of DVD and CD discs, Toshiba cannot guarantee that this DVD player will play every feature of every DVD bearing the DVD logo and/or every CD bearing the CD logo. As one of the creators of DVD technology, Toshiba DVD players are manufactured using the highest standards of quality, and as a result, such incompatibilities are rare.

Notes on copyright

The unauthorized recording, use, distribution, or revision of television programs, videotapes, DVDs and other materials, is prohibited under the Copyright Laws of the United States and other countries, and may subject you to civil and/or criminal liability.

This product incorporates copyright protection technology that is protected by method claims of certain U.S. patents and other intellectual property rights owned by Macrovision Corporation and other rights owners. Use of this copyright protection technology must be authorized by Macrovision Corporation, and is intended for home and other limited viewing uses only unless otherwise authorized by Macrovision Corporation. Reverse engineering or disassembly is prohibited.

- The product unit accompanying this user manual is licensed under certain intellectual property rights of certain third parties. In particular, this product is licensed under the following US patents: 5,991,715, 5,740,317, 4,972,484, 5,214,678, 5,323,396, 5,539,829, 5,606,618, 5,530,655, 5,777,992, 6,289,308, 5,610,985, 5,481,643, 5,544,247, 5,960,037, 6,023,490, 5,878,080, and under US Published Patent Application No. 2001-44713-A1.

This license is limited to private non-commercial use by end-user consumers for licensed contents. No rights are granted for commercial use. The license does not cover any product unit other than this product unit and the license does not extend to any unlicensed product unit or process conforming to ISO/IEC 11172-3 or ISO/IEC 13818-3 used or sold in combination with this product unit.

The license only covers the use of this product unit to encode and/or decode audio files conforming to the ISO/IEC 11172-3 or ISO/IEC 13818-3. No rights are granted under this license for product features or functions that do not conform to the ISO/IEC 11172-3 or ISO/IEC 13818-3.

Introduction

HANDLING CAUTIONS

- Before connecting other components to this player, be sure to turn them all off.
- Do not move the player while a disc is being played, or the disc may be scratched or broken, and the player's internal parts may be damaged.
- Do not put a flower vase filled with water or any small metal objects on the player.
- Be careful not to put your hand into the disc tray.
- Do not place anything other than the disc in the disc tray.
- Exterior interference such as lightning and static electricity can affect normal operation of this player. If this occurs, turn the player off and on again with the POWER button, or disconnect and then reconnect the AC power cord to the AC power outlet. The player will operate normally.
- Be sure to remove the disc and turn off the player after use.
- Disconnect the AC power cord from the AC outlet when you don't intend to use the player for long periods of time.
- Clean the disc by wiping in a straight line from the inside to the outside of the disc.

NOTES ON LOCATING

Place the DVD video player on a level surface. Do not use it on a shaky or unstable surface such as a wobbling table or inclined stand. The loaded disc may become disaligned and damage the DVD video player. When you place this DVD video player near a TV, radio, or VCR, the playback picture may become poor and the sound may be distorted. In this case, place the DVD video player away from the TV, radio, or VCR.

STORING DISCS

Do not store discs in a place subject to direct sunlight or near heat sources.
Do not store discs in places subject to moisture and dust such as a bathroom or near a humidifier.
Store discs vertically in a case. Stacking or placing objects on discs outside of their case may cause warping.

MAINTENANCE OF CABINET

For safety reasons, be sure to disconnect the AC power cord from the AC outlet.

- Do not use benzene, thinner, or other solvents for cleaning.
- Wipe the cabinet with a soft cloth.

Introduction

Before you start

Accessories



Remote Control



Batteries for Remote Control (AA Size)

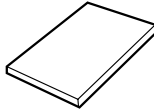

User's Manual

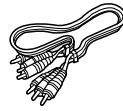

Video/Audio Cable



HDMI-HDMI Cable

Install Batteries in the Remote control

1

Open the battery cover on the back of the remote control.

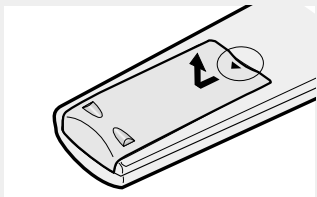

2

Insert two AA batteries. Make sure that the polarities (+ and -) are aligned correctly.

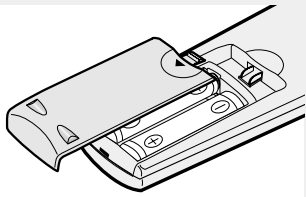

3

Replace the battery cover.

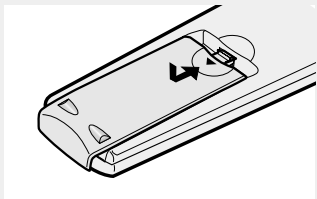

Operating with the remote control

Point the remote control at the remote sensor and press the buttons.

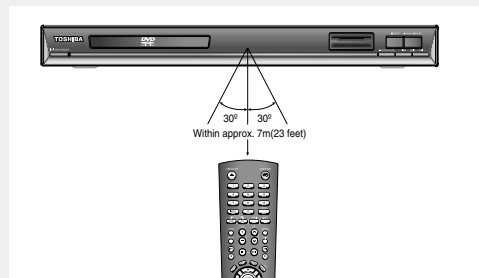

Distance : Approx. 7m (23 feet) from the front of the remote sensor.

Angle : Approx. 30° in each direction of the front of the remote sensor.

- Do not expose the remote sensor of the DVD video player to a strong light source such as direct sunlight or other illumination. If you do so, you may not be able to operate the DVD video player via the remote control.

If the remote control doesn't operate properly:

- Check the polarity +/- of the batteries (Dry-Cell).
- Check if the batteries are drained.
- Check if remote control sensor is blocked by obstacles.
- Check if there is any fluorescent lighting nearby.

Caution: Never throw batteries into a fire.

Notes:

- Be sure to use AA size batteries.
- Dispose of batteries in a designated disposal area.
- Batteries should always be disposed of with the environment in mind. Always dispose of batteries in accordance with applicable laws and regulations.

- If the remote control does not operate correctly, or if the operating range becomes reduced, replace batteries with new ones.
- When necessary to replace batteries in the remote control, always replace both batteries with new ones. Never mix battery types or use new and used batteries in combination.
- Always remove batteries from remote control if they are dead or if the remote control is not to be used for an extended period of time. This will prevent battery acid from leaking into the battery compartment.

Introduction

Table of Contents

Introduction

Safety Precautions	2
Important Safety Instructions	3
Before you start	6
Table of Contents	7
General Features	8
Type of Playable Discs	10
Front Panel	11
Front Panel Display	11
Rear Panel	12
Remote Control	13

Connections

Choosing a Connection	14
---------------------------------	----

Basic Functions

Playing a Disc	23
Using the Search and Skip Functions	25
Using the Display Function	26
Using the Disc and Title Menu	28
Using the Function Menu	29
Repeat Play	30
Slow Repeat Play	31
Program Play & Random Play	32

Advanced Functions

Selecting the Audio Language	33
Selecting the Subtitle Language	34
Changing the Camera Angle	35
Using the Instant Replay/Skip Function	36
Using the Marker Function	37
Using the Zoom Function	39
How to insert a Memory Card	40
DVD AUDIO Playback	41
Super Audio CD Playback	44
Clips Menu for MP3/JPEG/MPEG4	47
Folder Selection	47
MP3 Playback	48
MPEG4 Playback	50
Picture CD Playback	52
Picture CD Playback for HD-JPEG	53

Changing Setup Menu

Using the Setup Menu	55
Setting Up the Language Features	56
Setting Up the Audio Options	60
Setting Up the Display Options	64
Setting Up the Parental Control	67

Reference

Controlling a TV with the Remote Control	70
Troubleshooting	72
Specifications	74
Memo	75

Introduction

General Features

Excellent Sound

Dolby Digital, a technology developed by Dolby Laboratories, provides crystal clear sound reproduction.

Screen

Both regular and widescreen(16:9) pictures can be viewed.

Slow Motion

An important scene can be viewed in slow motion.

Program Play (CD)

You can program tracks to play in desired order.

Parental Control (DVD)

The parental control allows users to set the level necessary to prohibit children from viewing harmful movies such as those with violence, adult subject matter, etc.

Various On-Screen Menu Functions

You can select various languages (Audio/Subtitle) and screen angles while enjoying movies.

Progressive Scan

Progressive scanning creates an improved picture with double the scan lines of a conventional interlaced picture.

Digital Photo Viewer (JPEG)

You can view Digital Photos on your TV.

Repeat

You can repeat a song or movie simply by pressing the REPEAT button.

MP3

This unit can play discs created from MP3 files.

Instant Replay (DVD)

This function is used to replay the previous 10 seconds of a movie from the current position.

Instant Skip (DVD)

This function skips playback ahead 10 seconds.

Super Audio CD

Super Audio CD is a high quality audio format with higher sampling rates and fuller, richer sound as compared to regular CD.

DVD AUDIO

DVD AUDIO is a format specifically designed to provide the highest possible audio fidelity capable on DVD.

MPEG4

This unit can play MPEG4 formats within an avi file.

HDMI (High Definition Multimedia Interface)

HDMI reduces picture noise by allowing a pure digital video/audio signal path from the player to your TV.

Note

- Discs which cannot be played with this player.
 - DVD-ROM • DVD-RAM • WMA
 - CD-ROM • CDV
 - CDI • CVD
- CDGs play audio only, not graphics.
- Ability to play back may depend on recording conditions.
- DVD-R
- CD-RW
- DVD-RW (V mode)
- The unit may not play certain CD-R, CD-RW and DVD-R due to the disc type or recording conditions.

PROGRESSIVE SCAN OUTPUTS

[525p(480p) / 625p(576p)]

CONSUMERS SHOULD NOTE THAT NOT ALL HIGH DEFINITION TELEVISION SETS ARE FULLY COMPATIBLE WITH THIS PRODUCT AND MAY CAUSE ARTIFACTS TO BE DISPLAYED IN THE PICTURE, IN CASE OF 525(480) OR 625(576) PROGRESSIVE SCAN PICTURE PROBLEMS, IT IS RECOMMENDED THAT THE USER SWITCH THE CONNECTION TO THE 'STANDARD DEFINITION' OUTPUT. IF THERE ARE QUESTIONS REGARDING YOUR TV SET COMPATIBILITY WITH THIS MODEL 525p(480p) AND 625p(576p) DVD PLAYER, PLEASE CONTACT OUR CUSTOMER SERVICE CENTER.

Introduction

To ensure proper use of this product, please read this owner's manual carefully and retain for future reference.

This manual provides information on the operation and maintenance of your DVD Home Theater System.

Should the unit require service, contact an authorized service location.

Symbol Used in this Manual



The lightning flash symbol alerts you to the presence of dangerous voltage within the product enclosure that may constitute a risk of electric shock.



The exclamation point alerts you to the presence of important operating and maintenance / servicing instructions.



Indicates hazards likely to cause harm to the unit itself or other material damage.

About the Symbol Display

"" may appear on your TV display during operation and indicates that the function explained in this owner's manual is not available on that specific DVD video disc.

Notes on Discs

HANDLING DISCS

Do not touch the playback side of the disc. Hold the disc by the edges so that fingerprints do not get on the surface. Never stick paper or tape on the disc.

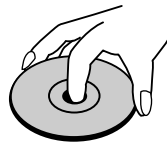

STORING DISCS

After playing, store the disc in its case. Do not expose the disc to direct sunlight or sources of heat and never leave it in a parked car exposed to direct sunlight.

CLEANING DISCS

Fingerprints and dust on the disc can cause poor picture quality and sound distortion. Before playing, clean the disc with a clean cloth. Wipe the disc from the centre out.

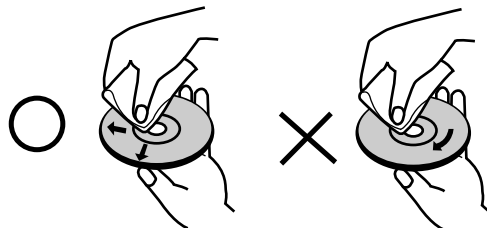





Do not use strong solvents such as alcohol, benzene, thinner, commercially available cleaners, or anti-static spray intended for older vinyl records.











Introduction

Type of Playable Discs

This DVD player is capable of playing the following types of discs with the corresponding logos:

Disc Types (Logos)	Recording Types	Disc Size	Max. Playing Time	Characteristics
DVD-VIDEO 	Audio + Video	5"	Single-sided 240 min. Double-sided 480 min.	<ul style="list-style-type: none"> - DVD contains excellent sound and video due to Dolby Digital and MPEG-2 system. - Various screen and audio functions can be easily selected through the on-screen menu.
		3 1/2"	Single-sided 80 min. Double-sided 160 min.	
VIDEO-CD 	Audio + Video	5"	74 min.	<ul style="list-style-type: none"> - Video with CD sound, VHS quality & MPEG-1 compression technology.
		3 1/2"	20 min.	
AUDIO-CD 	Audio	5"	74 min.	<ul style="list-style-type: none"> - CD is recorded as a Digital Signal with better audio quality, less distortion and less deterioration of audio quality over time.
		3 1/2"	20 min.	
DVD-AUDIO 	Audio + Video	5"	400 min.	<ul style="list-style-type: none"> - DVD AUDIO is a format specifically designed to provide the highest possible audio fidelity capable on DVD.
Super Audio CD 	Audio	5"	74 min.	<ul style="list-style-type: none"> - Super Audio CD is a high quality audio format with higher sampling rates and fuller, richer sound as compared to regular CD.

Disc Markings

	Play Region Number
	NTSC broadcast system in U.S.A, Canada, Korea, Japan, etc.
	PAL broadcast system in U.K, France, Germany, etc.
	Dolby Digital disc
	Stereo disc
	Digital Audio disc
	DTS disc
	MP3 disc
	DVD AUDIO disc
	Super Audio CD disc

You must only insert one DVD disc at a time. Inserting two or more discs will not allow playback and may cause damage to the DVD player.

Region Number

Both the DVD player and the discs are coded by region. These regional codes must match in order for the disc to play. If the codes do not match, the disc will not play.

The Region Number for this player is printed on the rear panel of the player.

DivX Certification

DivX, DivX Certified, and associated logos are trademarks of DivX, Inc and are used under license.



Introduction

Front Panel

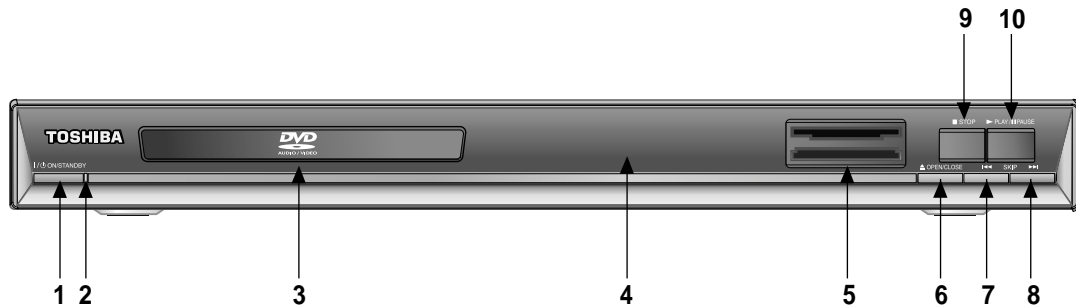

1. **ON/STANDBY (I/O)**
Use to turn your player on and off (standby).
2. **POWER Indicator**
This indicator will light up when the power is on.
3. **DISC TRAY**
Place the disc here.
4. **DISPLAY**
Operation indicators are displayed here.
5. **MULTI- CARD INPUT**
Insert a Memory Card.
6. **OPEN/CLOSE (▲)**
Press to open and close the disc tray.
7. **SKIP (◀◀) / SEARCH**
- Use to reverse skip a scene or music.
- Press and hold to search backward.
8. **SKIP (▶▶) / SEARCH**
- Use to forward skip a scene or music.
- Press and hold to search forward.
9. **STOP (■)**
Stops disc play.
10. **PLAY/PAUSE (▶||)**
Begin or pause disc play.

Front Panel Display

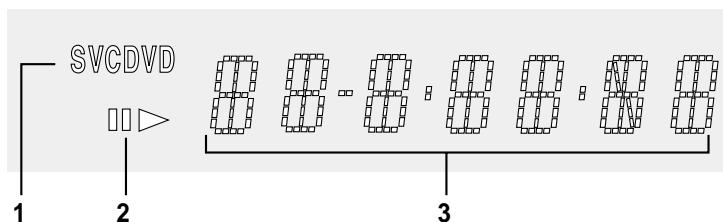

1. **Disc type indicators**
2. **Play / Pause**
3. **Displays various messages concerning operations such as PLAY, STOP, LOAD, etc.**
no DISC: No disc loaded.
OPEN: The disc tray is open.
LOAD: Player is loading disc information.

Introduction

Rear Panel

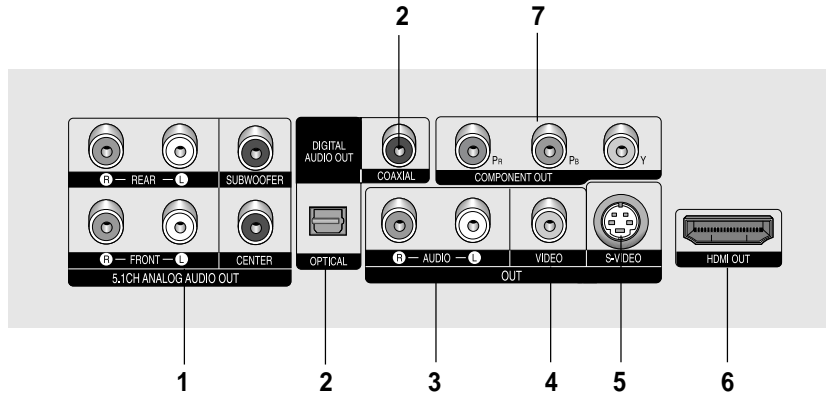

1. 5.1CH ANALOG AUDIO OUT JACKS

- Connect to an amplifier with 5.1ch analog input jacks.

2. DIGITAL AUDIO OUT JACKS

- Use either an optical or coaxial digital cable to connect to a compatible Dolby Digital receiver.
- Use either an optical or coaxial digital cable to connect to an A/V Amplifier that contains a Dolby Digital, MPEG2 or DTS decoder.

3. AUDIO OUT JACKS

- Connect to the Audio input jacks of your television or audio/video receiver.

4. VIDEO OUT JACK

- Use a video cable to connect to the Video input jack on your television.
- The Video Output in Setup Menu must be set to COMPONENT(I-SCAN) or COMPOSITE/S-VIDEO.

5. S-VIDEO OUT JACK

- Use the S-Video cable to connect this jack to the S-Video jack on your television for higher picture quality.
- The Video Output in Setup Menu must be set to COMPOSITE/S-VIDEO.

6. HDMI OUT JACK

- Use the HDMI cable to connect this jack to the HDMI jack on your television for the best quality picture.
- If an HDMI cable is connected to an HDMI-compatible TV, HDMI will be output automatically a maximum of 10 seconds later.
- If you want to use a Video, S-Video or Component Output, unplug HDMI cable.

7. COMPONENT VIDEO OUT JACKS

- Use these jacks if you have a TV with Component Video in jacks. These jacks provide P_R, P_B and Y video.
- If HDMI/COMPONENT(P-SCAN) Video Output is selected in Setup Menu, progressive scan mode will work.
- If COMPONENT(I-SCAN) Video Output is selected in Setup Menu, interlaced scan mode will work.

Note

- Consult your TV User's Manual to find out if your TV supports Progressive Scan (P-SCAN). If Progressive Scan is supported, follow the TV User's Manual regarding Progressive Scan settings in the TV's menu system.
- If HDMI/COMPONENT(P-SCAN) Video Output is selected in Setup Menu, Video and S-Video Outputs do not work.
- There may be no image output if the DVD player is connected to a TV or display that is not compatible with the above format.
- Refer to the TV's instruction manual for detailed information regarding the HDMI terminal.
- See pages 64 ~ 66 to get more information on how to use the setup menu.

Connections

Choosing a Connection

The following shows examples of connections commonly used to connect the DVD player with a TV and other components.

Before Connecting the DVD Player

- Always turn off the DVD player, TV, and other components before you connect or disconnect any cables.
- Refer to the user's manual of the additional components (such as a TV) you are connecting for more information on those particular components.

Connection to a TV (Video)

1

Using video/audio cables, connect the **VIDEO (yellow)/AUDIO (red and white) OUT** terminals on the rear of the DVD player to the **VIDEO (yellow)/AUDIO (red and white) IN** terminals of your TV.

2

Turn on the DVD player and TV.

3

Press the input selector on your TV remote control until the Video signal from the DVD player appears on the TV screen.

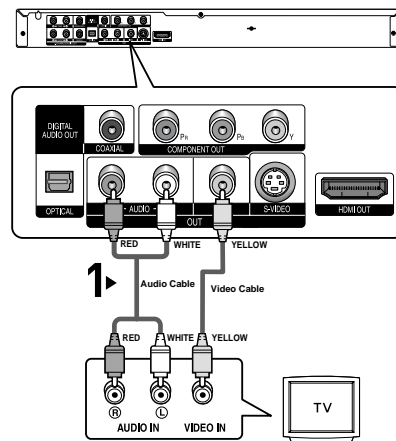

Note

- **Noise may be generated if the audio cable placed too close to the power cable.**
- If you want to connect to an Amplifier, please refer to the Amplifier connection page. (See pages 20 to 22)
- The number and position of terminals may vary depending on your TV set. Please refer to the user's manual of your TV.
- If there is one audio input terminal on the TV, connect it to the [AUDIO OUT][left] (white) terminal of the DVD player.
- If you press the **V.OUT** button when DVD Player is in stop mode or no disc is inserted, the Video Output mode changes in the following sequence: (COMPOSITE/S-VIDEO → COMPONENT(I-SCAN) → HDMI/COMPONENT(P-SCAN))
If HDMI/COMPONENT(P-SCAN) mode is selected and your TV does not support HDMI or progressive scan, you cannot see any picture. Press the **V.OUT** button until the picture can be seen on the screen.
- When the Video Output in Setup menu is set to HDMI/COMPONENT(P-SCAN), the Video and S-Video Outputs do not work.

Connections

Connection to a TV (S-Video)

- Connecting to your TV using an S-Video cable.
- You will enjoy high quality images. S-Video separates the picture element into black and white(Y) and colour(C) signals to present clearer images than regular video input mode. (Audio signals are delivered through the audio output.)

1

Using an S-Video cable (not supplied), connect the **S-VIDEO OUT** terminal on the rear of the DVD player to the **S-VIDEO IN** terminal of your TV.

2

Using the audio cables, connect the **AUDIO (red and white) OUT** terminals on the rear of the DVD player to the **AUDIO (red and white) IN** terminals of your TV. Turn on the DVD player and TV.

3

Press the input selector on your TV remote control until the S-Video signal from the DVD player appears on your TV screen.

4

Set the Video Output to **COMPOSITE/S-VIDEO** in the Display Setup menu. (See pages 64 to 65)
You can use the **V.OUT** button to change the Video Output mode. (See page 14)

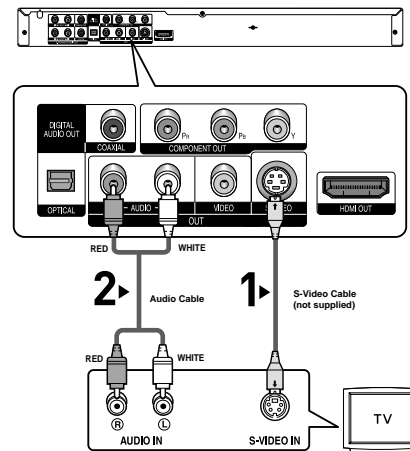

Note

- If you want to connect to an Amplifier, please refer to the Amplifier connection page. (See pages 20 to 22)
- The number and position of terminals may vary depending on the TV set. Please refer to the user's manual of your TV.

Connections

Connection to a TV (Interlace)

- Connecting to your TV using Component video cables.
- You will enjoy high quality and accurate colour reproduction images. Component video separates the picture element into black and white (Y), blue (P_B), red (P_R) signals to present clear and clean images. (Audio signals are delivered through the audio output.)

1

Using component video cables (not supplied), connect the **COMPONENT VIDEO OUT** terminals on the rear of the DVD player to the **COMPONENT IN** terminals of your TV.

2

Using the audio cables, connect the **AUDIO (red and white) OUT** terminals on the rear of the DVD player to the **AUDIO (red and white) IN** terminals of your TV. Turn on the DVD player and TV.

3

Press the input selector on your TV remote control until the Component signal from the DVD player appears on the TV screen.

4

Set the Video Output to **COMPONENT(I-SCAN)** in the Display Setup menu. (See pages 64 to 65)
You can use the **V.OUT** button to change the Video Output mode. (See page 14)

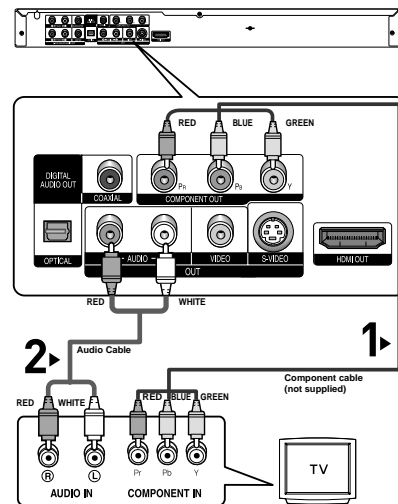

Note

- If Video output is incorrectly set to **COMPOSITE/S-VIDEO** with the Component cables connected, the screen will turn red.
- If you want to connect to an Amplifier, please refer to the Amplifier connection page. (See pages 20 to 22)
- The component terminal of your TV may be marked "R-Y, B-Y, Y" or "Cr, Cb, Y" instead of "P_R, P_B, Y" depending on the manufacturer. The number and position of terminals may vary depending on the TV set. Please refer to the user's manual of your TV.

Connections

Connection to a TV (Progressive)

1

Using component video cables (not supplied), connect the **COMPONENT VIDEO OUT** terminals on the rear of the DVD player to the **COMPONENT IN** terminals of your TV.

2

Using the audio cables, connect the **AUDIO (red and white) OUT** terminals on the rear of the DVD player to the **AUDIO (red and white) IN** terminals of your TV. Turn on the DVD player and TV.

3

Press the input selector on your TV remote control until the Component signal from the DVD player appears on the TV screen.

4

Set the Video Output to **HDMI/COMPONENT(P-SCAN)** in the Display Setup menu. (See pages 64 to 65)
You can use the **V.OUT** button to change the Video Output mode. (See page 14)

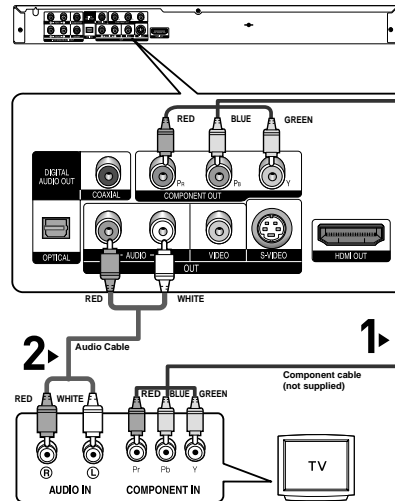

Connections

To see the progressive video output,

- Consult your TV User's Manual to find out if your TV supports Progressive Scan. If Progressive Scan is supported, follow the TV User's Manual regarding Progressive Scan settings in the TV's menu system.
- Depending on your TV, the connection method may differ from the illustration above.

Note

- What is "Progressive Scan"?
Progressive scan has twice as many scanning lines as the interlace output method. Progressive scanning method provides better and clearer picture quality.

Connections

Connecting to a TV with HDMI Jack

1

Using the HDMI cable, connect the **HDMI OUT** terminal on the rear of the DVD player to the **HDMI IN** terminal of your TV.

2

Press the input selector on your TV remote control until the HDMI signal from the DVD player appears on your TV screen.

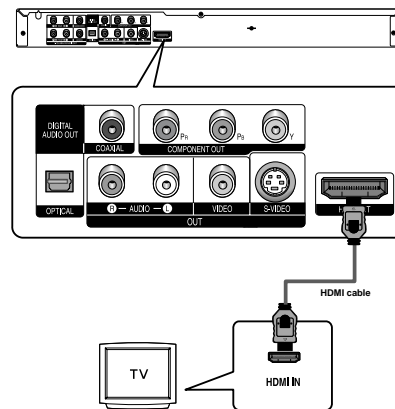

HDMI VIDEO Specifications

When you press the **HDMI** button, 576p, 720p and 1080i are selected in order.

The first press of the **HDMI** button brings up the current resolution.

The second press allows you to change the HDMI output resolution.

- Depending on your TV, certain HDMI output resolutions may not work.
Because HDMI is an evolving technology, it is possible that some devices with an HDMI input may not operate properly with this DVD player.
- Please refer to the user's manual of your TV.
- If HDMI cable is plugged into TV, the DVD player's output is set to HDMI within 10 seconds.
- If you set the HDMI output resolution 720p or 1080i, HDMI output provides better picture quality.

Connections

- **HDMI (High Definition Multimedia Interface)**

HDMI is an interface to enable the digital transmission of video and audio data with just a single connector. Using HDMI, the DVD player transmits a digital video and audio signal and displays a vivid picture on a TV having an HDMI input jack.

- **HDMI, the HDMI logo and High-Definition Multimedia Interface are trademarks or registered trademarks of HDMI Licensing LLC.**

- **HDMI connection description**

HDMI connector - Both uncompressed video data and digital audio data (LPCM or Bit Stream data).

- Though the player uses a HDMI cable, the player outputs only a pure digital signal to the TV.
- If TV does not support HDCP (High-bandwidth Digital content protection), snow noise appears on the screen.

- **Why does Toshiba use HDMI?**

Analog TVs require an analog video/audio signal. However, when playing a DVD, the data transmitted to a TV is digital. Therefore either a digital-to-analog converter (in the DVD player) or an analog-to-digital converter (in the TV) is required. During this conversion, the picture quality is degraded due to noise and signal loss. HDMI technology is superior because it requires no D/A conversion and is a pure digital signal from the player to your TV.

- **What is the HDCP?**

HDCP (High-bandwidth Digital Content Protection) is a system for protecting DVD content output via HDMI from being copied. It provides a secure digital link between a video source (PC, DVD, etc.) and a display device (TV, Projector, etc.). Content is encrypted at the source device to prevent unauthorized copies from being made.

Connections

Connection to an Audio System (2 Channel Amplifier)

1

Using the audio cables, connect the **AUDIO (red and white) OUT** terminals on the rear of the DVD player to the **AUDIO (red and white) IN** terminals of the Amplifier.

2

Using the video signal cable(s), connect the **VIDEO, S-VIDEO, COMPONENT** or **HDMI OUT** terminals on the rear of the DVD player to the **VIDEO, S-VIDEO, COMPONENT** or **HDMI IN** terminal of your TV as described on pages 14 to 18.

3

Turn on the DVD player, TV, and Amplifier.

4

Press the input select button of the Amplifier to select **external input** in order to hear sound from the DVD player. Refer to your Amplifier's user manual to set the Amplifier's audio input.

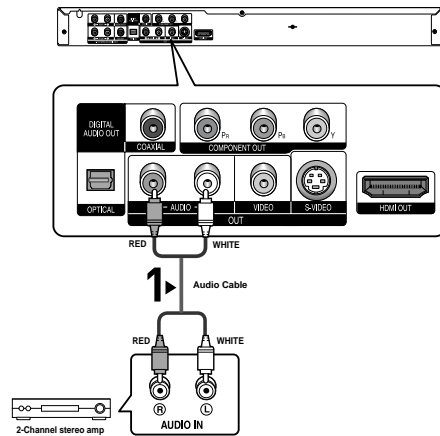

Note

- Please turn the volume down when you turn on the Amplifier. Sudden loud sound may cause damage to the speakers and your ears.
- Please set the audio in the menu screen according to the Amplifier. (See pages 60 to 61)
- The position of terminals may vary depending on the Amplifier. Please refer to the user's manual of the Amplifier.

Connections

Connection to an Audio System (Dolby Digital, MPEG2 or DTS Amplifier)

1

If using an optical cable (not supplied), connect the **DIGITAL AUDIO OUT (OPTICAL)** terminal on the rear of the DVD player to the **DIGITAL AUDIO IN (OPTICAL)** terminal of the Amplifier. If using a coaxial cable (not supplied), connect the **DIGITAL AUDIO OUT (COAXIAL)** terminal on the rear of the DVD player to the **DIGITAL AUDIO IN (COAXIAL)** terminal of the Amplifier.

2

Using the video signal cable(s), connect the **VIDEO, S-VIDEO, COMPONENT** or **HDMI OUT** terminals on the rear of the DVD player to the **VIDEO, S-VIDEO, COMPONENT** or **HDMI IN** terminals of your TV as described on pages 14 to 18.

3

Turn on the DVD player, TV, and Amplifier.

4

Press the input select button of the Amplifier to select **external input** in order to hear sound from the DVD player. Refer to your Amplifier's user manual to set the Amplifier's audio input.

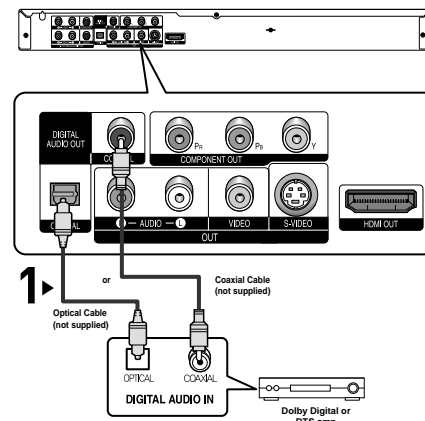

Note

- **Please turn the volume down when you turn on the Amplifier. Sudden loud sound may cause damage to the speakers and your ears.**
- Please set the audio in the menu screen according to the Amplifier. (See pages 60 to 61)
- The position of terminals may vary depending on the Amplifier. Please refer to the user's manual of the Amplifier.
- Please remove the dust cover before using the optical cable (not included) and put the cover on the cable again when it's not used.
- DVD-AUDIO only plays back two channel audio through the Digital Audio out. Multi-channel DVD-Audio discs are output through the Analog outputs.
- SACD plays back only through the Analog outputs. (See pages 60 to 61)

Connections

Connection to a 5.1CH Analog Amplifier

1

If using audio cables for 5.1 CH Analog Amplifier (not supplied) connect the **5.1CH ANALOG AUDIO OUT** terminals on the rear of the DVD player to the **5.1CH ANALOG AUDIO IN** terminals of the 5.1CH Analog Amplifier.

2

Using the video signal cable(s), connect the **VIDEO, S-VIDEO, COMPONENT** or **HDMI OUT** terminals on the rear of the DVD player to the **VIDEO, S-VIDEO, COMPONENT** or **HDMI IN** terminals of your TV as described on pages 14 to 18.

3

Turn on the DVD player, TV, and Amplifier.

4

Press the input select button of the Amplifier to select **external input** in order to hear sound from the DVD player. Refer to your Amplifier's user manual to set the Amplifier's audio input.

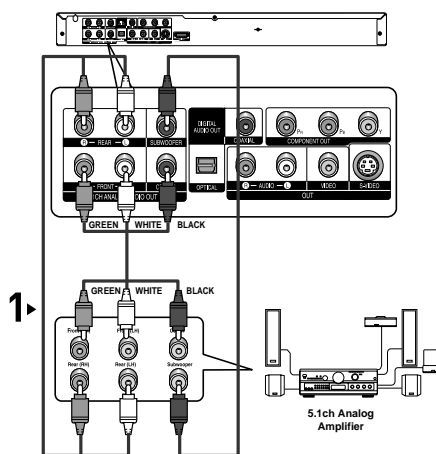

Note

- Please turn the volume down when you turn on the Amplifier. Sudden loud sound may cause damage to the speakers and your ears.
- Please set the audio in the menu screen according to the Amplifier. (See pages 60 to 63)
- The position of terminals may vary depending on the Amplifier. Please refer to the user's manual of the Amplifier.

Basic Functions

Playing a Disc

Before Play

- Turn on your TV and set it to the correct Video Input on the TV's remote control.
- If you connected an external Audio System, turn on your Audio System and set it to the correct Audio Input.

After plugging in the player, the first time you press the DVD **POWER** button, this screen comes up: If you want to select a language, press a **NUMBER** button. (This screen will only appear when you plug in the player for the first time.) If the language for the startup screen is not set, the settings may change whenever you turn the power on or off. Therefore, make sure that you select the language you want to use. Once you select a menu language, you can change it by pressing the **▶||** button on the front panel of the unit for more than 5 seconds with no disc in the unit. Then the **SELECT MENU LANGUAGE** window appears again where you can reset your preferred language.



Playback

1

Press the **OPEN/CLOSE** (**▲**) button. The **STANDBY** indicator light goes out and the tray opens.

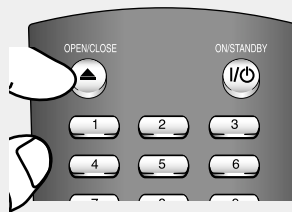

2

Place a disc gently into the tray with the disc's label facing up.



3

Press the **PLAY/PAUSE** (**▶||**) button or **OPEN/CLOSE** (**▲**) button to close the disc tray.



◀ RESUME function

When you stop disc play, the player remembers where you stopped, so when you press **PLAY/PAUSE** (**▶||**) button again, it will pick up where you left off. (unless the disc is removed or the player is unplugged, or if you press the **STOP** (**■**) button twice.)

Basic Functions

4

Stopping Play

Press the **STOP** (■) button during play.



Note

- If the player is left in the stop mode for more than one minute without any user interaction, a screen saver will be activated. Press the **PLAY/PAUSE** (▶||) button to resume normal play.
- If the player is left in the stop mode for more than 30 minutes, the power will automatically turn off. (Automatic Power-Off Function)

5

Removing Disc

Press the **OPEN/CLOSE** (▲) button.

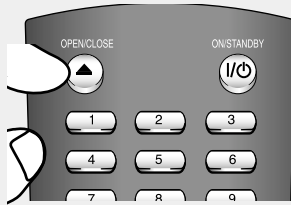

6

Pausing Play

Press the **PLAY/PAUSE** (▶||) or **STEP** button on the remote control during play.

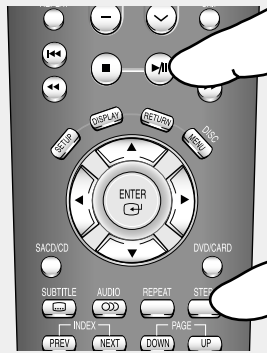

◀ Screen pauses, no sound.

To resume, press the **PLAY/PAUSE** (▶||) button once again.

Note

If the player is left for about 5 minutes in pause mode, it will stop.

7

Step Motion Play (Except CD)

Press the **STEP** button on the remote control during play.



◀ Each time the button is pressed, a new frame will appear.

No sound is heard during STEP mode.

Press the **PLAY/PAUSE** (▶||) button to resume normal play.

You can only perform step motion play in the forward direction.

8

Slow Motion Play (Except CD)

Press the **SEARCH** (▶▶) button to choose the play speed between 1/8, 1/4 and 1/2 of normal during PAUSE or STEP mode.



◀ No sound is heard during slow mode.

Press the **PLAY/PAUSE** (▶||) button to resume normal play.

Reverse slow motion play will not work.

Note

This (⊙) icon appears when an invalid button is pressed.

Basic Functions

Using the Search and Skip Functions

During play, you can search quickly through a chapter or track, and use the skip function to jump to the next selection.

Searching through a Chapter or Track

During play, press the **SEARCH** (◀◀ or ▶▶) button on the remote control for more than 1 second.

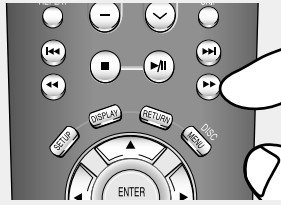

◀ During play, press the **SEARCH** (◀◀ or ▶▶) button and press again to search at a faster speed.

DVD	2X, 4X, 8X, 32X, 128X
VCD	4X, 8X
CD/SACD/DVD-AUDIO	2X, 4X, 8X

Note

- The speed marked in this function may be different from the actual playback speed.
- No sound is heard during search mode (Except CD).

Skipping Tracks

During play, press the **SKIP** (◀◀ or ▶▶) button.

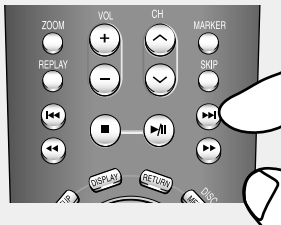

- When playing a DVD, if you press the **SKIP** (▶▶) button, it moves to the next chapter. If you press the **SKIP** (◀◀) button, it moves to the beginning of the chapter. One more press makes it move to the beginning of the previous chapter.
- When playing a VCD 2.0 in Menu Off mode, or a VCD 1.1 or a CD, if you press the **SKIP** (▶▶) button, it moves to the next track. If you press the **SKIP** (◀◀) button, it moves to the beginning of the track. One more press makes it move to the beginning of the previous track.
- If a track exceeds 15 minutes when playing a VCD and you press the ▶▶ button, it moves forward 5 minutes. If you press the ◀◀ button, it moves backward 5 minutes.

Note

When VCD 2.0 is in Menu Off mode only, this function works. Select Menu Off by pressing the DISC MENU button.

Basic Functions

Using the Display Function

When Playing a DVD/VCD/CD/MPEG4

1

During play, press the **DISPLAY** button on the remote control.

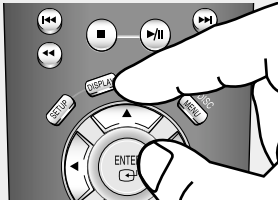

◀ You can select Info in the function menu by pressing the MENU button.

2

Press the ▲/▼ buttons to select the desired item.

DVD



VCD

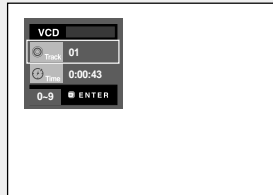

◀ When VCD2.0 is in Menu Off mode only, this function works. Select Menu Off by pressing the DISC MENU button.

CD

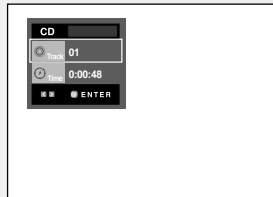

MPEG4

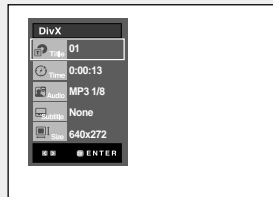

Basic Functions

3

Press the ◀▶ buttons to make the desired setup and then press the **ENTER** button.

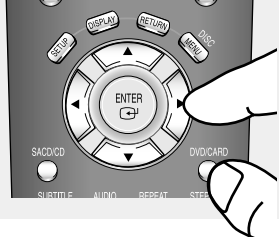

◀ You may use the number buttons on the remote control to directly access a title, chapter or to start the playback from a desired time.

4

To make the screen disappear, press the **DISPLAY** button again.

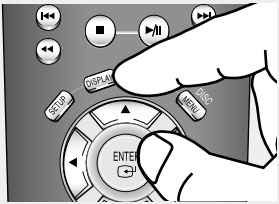

Note

	<p>To access the desired title when there is more than one in the disc. For example, if there is more than one movie on a DVD, each movie will be identified.</p>
 	<p>Most DVD discs are recorded in chapters so that you can quickly find a specific passage (similar to tracks on an audio CD).</p>
	<p>Allows playback of the film from a desired time. You must enter the starting time as a reference. The time search function does not operate on some discs.</p>
	<p>Refers to the film's soundtrack language. In the example, the soundtrack is played in English 5.1CH. A DVD disc can have up to eight different soundtracks. The MP3 and AC3 are supported.(DivX)</p>
	<p>Refers to the subtitle languages available in the disc. You will be able to choose the subtitle languages or turn them off from the screen. A DVD disc can have up to 32 different subtitles.</p>
	<p>(DivX) File Size has a relationship with resolution of a title. The larger file size is, the higher resolution is displayed. If the file resolution is small, it scales up automatically. So you can see the larger screen.</p>

Basic Functions

Using the Disc and Title Menu

Using the Disc Menu (DVD)

1

During the playback of a DVD disc, press the **SETUP** button on the remote control.

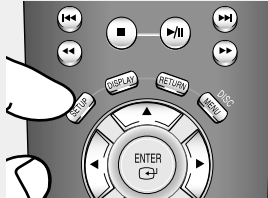

2

Press the **▲/▼** buttons to select **Disc Menu**, then press the **▶** or **ENTER** button.



Note

- Depending on a disc, the Disc Menu may not work.
- You can also use the Disc Menu, using the DISC MENU button on the remote control.

Using the Title Menu (DVD)

1

During the playback of a DVD disc, press the **SETUP** button on the remote control.

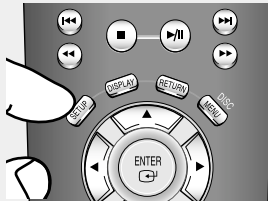

2

Press the **▲/▼** buttons to select **Title Menu**, then press the **▶** or **ENTER** button.

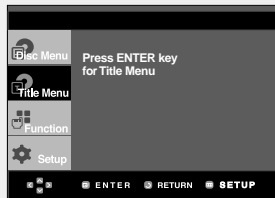

Note

- Depending on a disc, the Title Menu may not work.
- Title Menu will only be displayed if there are at least two titles in the disc.

Basic Functions

Using the Function Menu

Using the Function Menu (DVD/VCD)

1

Press the **SETUP** button during playback.

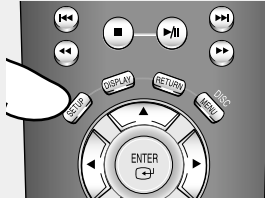

2

Press the ▲/▼ buttons to select **Function**, then press the ► or **ENTER** button.

- Info (See pages 26 to 27)
- Zoom (See page 39)
- Marker (See pages 37 to 38)
- Repeat (See pages 30 to 31)
- Angle (See page 35)
- Front Display

For Front display, you can select the brightness of the display to 3 different modes : Auto, Bright, Dim.

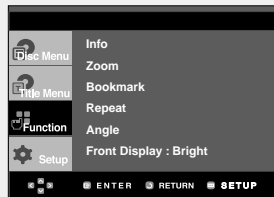

3

Press the ▲/▼ buttons to select one of the six functions. Then press the ► or **ENTER** button to access the function.

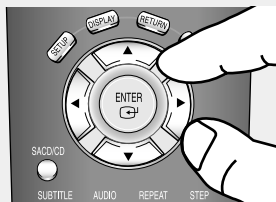

◀ You can also directly select these functions using their respective buttons on the remote control.

Note

- When VCD2.0 is in Menu Off mode only, this function works. Select Menu Off by pressing the DISC MENU button.

Basic Functions

Repeat Play

Repeat the current track, chapter, title, a chosen section (A-B), or all of the disc.

When playing a DVD/VCD/CD

1

Press the **REPEAT** button on the remote control. Repeat screen appears.

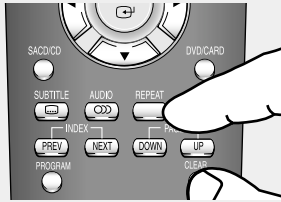

2

Press the ◀▶ buttons to select **Chapter**, **Title** or **A-B**, then press the **ENTER** button.

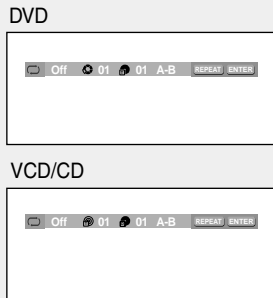

◀ DVD repeats play by chapter or title, CD and VCD repeat play by disc or track.

Chapter (⊙): repeats the chapter that is playing.

Title (Ⓜ): repeats the title that is playing.

Disc (Ⓛ): repeats the disc that is playing.

Track (Ⓜ): repeats the track that is playing.

A-B: repeats a segment of the disc that you select.

Using the A-B Repeat function

1. Press the REPEAT button on the remote control.
2. Press the ◀▶ buttons to Select A-B.
3. Press the ENTER button at the point where you want repeat play to start (A). B is automatically highlighted.
4. Press the ENTER button at the point where you want the repeat play to stop (B).
- To return to normal play, press the CLEAR button.

Note

A-B REPEAT does not allow you to set point (B) until at least 5 seconds of playback time has elapsed after point (A) has been set.

3

To return to normal play, press **REPEAT** button again, then press the ◀▶ buttons to select **Off** and press **ENTER** button.

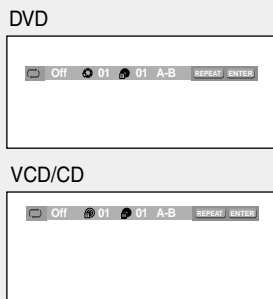

Note

- Depending on a disc, the Repeat function may not work.
- When VCD2.0 is in Menu Off mode only, this function works. Select Menu Off by pressing the DISC MENU button.

Basic Functions

Slow Repeat Play

This feature allows you slowly to repeat scenes containing sports, dancing, musical instruments being played etc., so you can study them more closely.

When playing a DVD/VCD

1

During play, press the **PLAY/PAUSE** (▶/||) button.

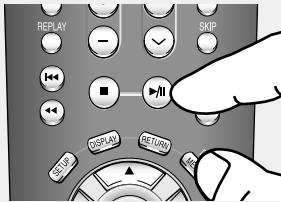

2

Press the **SEARCH** (▶▶) button to choose the play speed between 1/8, 1/4 and 1/2 of normal during PAUSE or STEP mode.



3

Press the **REPEAT** button on the remote control. Press the ◀▶ buttons to select A-B.

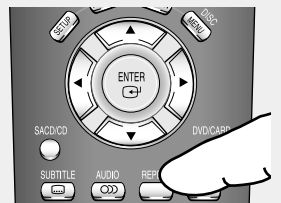

4

Press the **ENTER** button at the point where you want repeat play to start (A). B is automatically highlighted. Press the **ENTER** button at the point where you want the repeat play to stop (B).



5

To return to normal play, press the **CLEAR** button and then press the **PLAY/PAUSE** (▶/||) button.

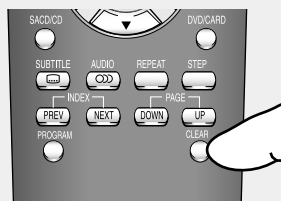

◀ To set A-B REPEAT, set (A) first, then set (B) after the following slow play time has elapsed:

1/8x: wait 40 seconds, then press B

1/4x: wait 20 seconds, then press B

1/2x: wait 10 seconds, then press B

◀ The disc will play from A to B repeatedly at the speed you chose.

Note

When VCD2.0 is in Menu Off mode only, this function works. Select Menu Off by pressing the DISC MENU button.

Basic Functions

Program Play & Random Play

Program Play (CD)

Program Play allows you to select the order in which you want tracks to play.

1

During play, press the **PROGRAM** button.

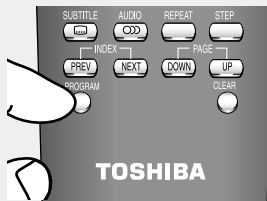

2

Press the ◀▶ buttons to select **PROGRAM**.
Press the **ENTER** button.

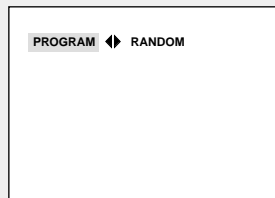

3

Press the ▲/▼/◀▶ buttons to select the first track to add to the program.
Press the **ENTER** button.
The selection numbers appear in the Program Order box.

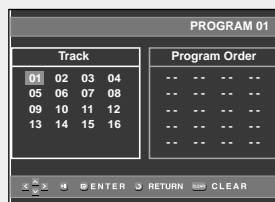

- ◀ - To return to the previous menu screen, press the **RETURN** button.
- To cancel the selected program order, press the **CLEAR** button.
- This unit can support a maximum of 20 programmed tracks.

4

Press the **PLAY/PAUSE** (▶||) button.
The disc will be played in programmed order.



Random Play (CD)

Random Play plays a disc's tracks in random order.

1

Press the **PROGRAM** button.

2

Press the ◀▶ buttons to select **RANDOM**.
Press the **ENTER** button.

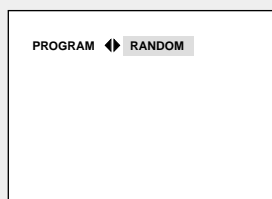

Note

- Depending on a disc, the Program and Random Play functions may not work.
- While in playback mode, press the **CLEAR** button on the remote control to cancel Program Play or Random Play.

Advanced Functions

Selecting the Audio Language

You can select a desired audio language quickly and easily with the AUDIO button.

Using the AUDIO button (DVD/VCD/CD)

1

Press the **AUDIO** button.
The Audio changes when the button is pressed repeatedly.

- The audio languages are represented by abbreviations.

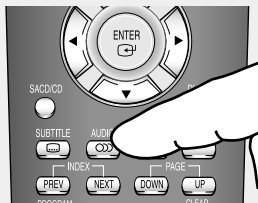

DVD

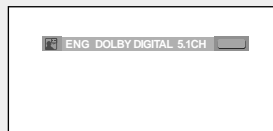

When playing a VCD or CD, you can select among **Stereo, Right or Left**.

VCD/CD



2

To remove the **AUDIO** icon, press the **CLEAR** or **RETURN** button.



Note

- This function depends on audio languages that are encoded on the disc and may not work.
- A DVD disc can contain up to 8 audio languages.
- To have the same audio language come up whenever you play a DVD; Refer to "Using the Audio Language" on page 58.

Advanced Functions

Selecting the Subtitle Language

You can select a desired subtitle quickly and easily with the SUBTITLE button.

Using the SUBTITLE button (DVD/MPEG4)

1

Press the **SUBTITLE** button.

The subtitle changes when the button is pressed repeatedly.

The subtitle languages are represented by abbreviations.

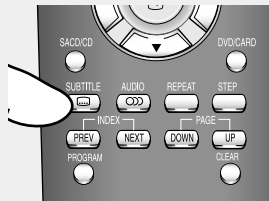

DVD



MPEG4



Press the ◀▶ buttons to select the desired subtitle language on a MPEG4 then press the **ENTER**.

2

To remove the **SUBTITLE** icon, press the **CLEAR** or **RETURN** button.



Note

- Depending on DVDs, you can change desired subtitle in the Disc Menu. Press the DISC MENU button.
- This function depends on what subtitles are encoded on the disc and may not work on all DVDs.
- A DVD disc can contain up to 32 subtitle languages.
- To have the same subtitle language come up whenever you play a DVD; Refer to "Using the Subtitle Language" on page 59.

Advanced Functions

Changing the Camera Angle

When a DVD contains multiple angles of a particular scene, you can use the ANGLE function.

Using the Angle Function (DVD)

If the disc contains multiple angles, the ANGLE appears on the screen.

1

During play or pause mode, press the **SETUP** button on the remote control.

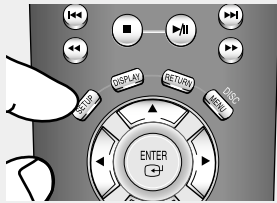

2

Press the **▲/▼** buttons to select **Function**, then press the **▶** or **ENTER** button.

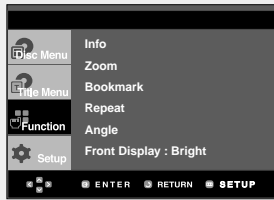

3

Press the **▲/▼** buttons to select **Angle**, then press the **▶** or **ENTER** button.

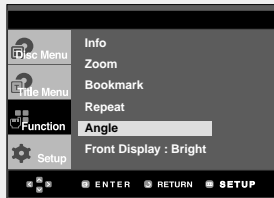

4

Press the **◀/▶** button repeatedly to select the desired angle. To remove the ANGLE icon, press the **CLEAR** or **RETURN** button.



Note

If the disc has only one angle, this feature won't work. Currently, very few discs have this feature.

Advanced Functions

Using the Instant Replay/Skip Function

Using the Instant Replay function (DVD)

If you miss a scene, you can see it again using this function.

Press the **REPLAY** button.

- The current scene moves backward about 10 seconds, and plays back.

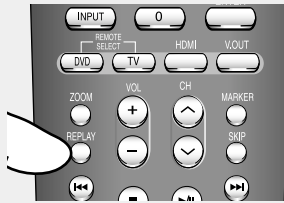

Using the Instant Skip function (DVD)

Use this function to skip playback about 10 seconds ahead of the current scene.

Press the **SKIP** button.

- Playback will skip ahead 10 seconds.



Note

Depending on the disc, these functions may not work.

Advanced Functions

Using the Marker Function

This feature lets you bookmark sections of a DVD or VCD (Menu Off mode) so you can quickly find them at a later time.

Using the Marker Function (DVD/VCD)

1

During play, press the **MARKER** button on the remote control.

Using the SETUP button.
During play, press the **SETUP** button on the remote control.

Press the **▲/▼** buttons to select **Function**, then press the **▶** or **ENTER** button.

Press the **▲/▼** buttons to select **Bookmark**, then press the **▶** or **ENTER** button.

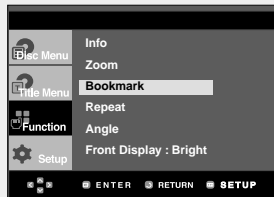
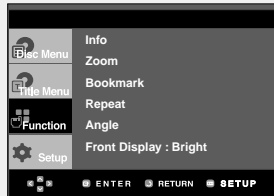

2

When you reach the scene you want to mark, press the **ENTER** button. Up to three scenes may be marked at a time.

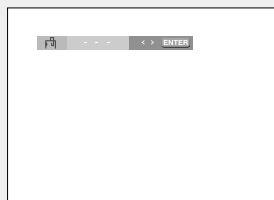

Note

- When VCD2.0 is in Menu Off mode only, this function works. Select Menu Off by pressing the DISC MENU button.
- Depending on a disc, the Bookmark function may not work.

Advanced Functions

Recalling a Marked Scene

1

During play, press the **MARKER** button on the remote control.



2

Press the ◀▶ buttons to select a marked scene.



3

Press the **PLAY/PAUSE** (▶||) button to skip to the marked scene.

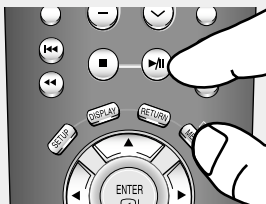

Clearing a Marker

1

During play, press the **MARKER** button on the remote control.



2

Press the ◀▶ buttons to select the bookmark number you want to delete.



3

Press the **CLEAR** button to delete a bookmark number.

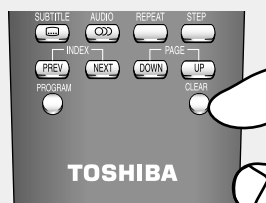

Advanced Functions

Using the Zoom Function

Using the Zoom Function (DVD/VCD)

1

During play, press the **ZOOM** button on the remote control.

Using the SETUP button.

During play or pause mode, press the **SETUP** button on the remote control.

Press the **▲/▼** buttons to select **Function**, then press the **▶** or **ENTER** button.

Press the **▲/▼** buttons to select **Zoom**, then press the **▶** or **ENTER** button.

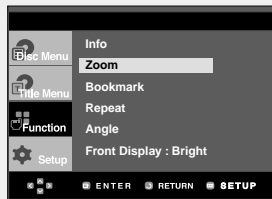
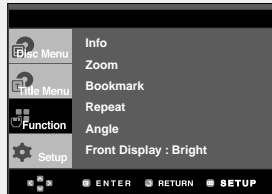

2

Press the **▲/▼** or **◀/▶** buttons to select the part of the screen you want to zoom in on.
Press the **ENTER** button.

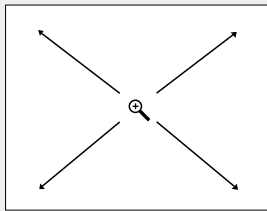

◀ During DVD play, press **ENTER** to zoom in 2X/4X/2X/Normal in order.

During VCD play, press **ENTER** to zoom in 2X/Normal in order.

Note







When VCD2.0 is in Menu Off mode only, this function works. Select Menu Off by pressing the **DISC MENU** button.

Advanced Functions

How to insert a Memory Card

This unit accepts 11 different types of Memory Cards

Insert the Memory Card correctly with the label facing up, otherwise it may not work.

	Card Mark	Contents	Playable card capacity
SD(Secure Digital™) memory card		MP3/ JPEG files	32 MB- 1 GB
MMC (MultiMediaCard™)			8 MB- 1 GB
xD-Picture card			16 MB- 1 GB
Memory Stick™			16 MB- 128 MB
Memory Stick™ (Pro)			128 MB- 2 GB
CompactFlash® memory card (Type 1)			8 MB- 4 GB
CompactFlash® memory card (Type 2)			8 MB- 4 GB

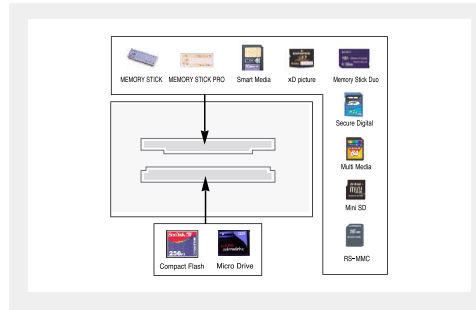

Multi card slot support 11 types of memory cards: Memory Stick, Memory Stick-Pro, Memory Stick Duo, SD, Mini SD Card and xD-Picture Card, MMC, RS-MMC, Smart Media Card, Compact Flash and Micro Drive. When cards are inserted in two slots, the card which is inserted first has a priority on playback.

Toshiba is an authorized licensee of the Compact Flash® registered trademark. SD is a trademark of SD Card Association. MMC and MultiMedia Card are trademarks of Infineon Technologies AG and licensed to MMCA (MultiMediaCard Association). Memory Stick is a trademark of Sony Corporation.

xD-Picture Card is a trademark of Fuji Photo Film Co., Ltd.

SmartMedia is a trademark of Toshiba Corp.

Micro Drive is a trademark of Hitachi Global Storage Technologies Netherlands B.V.

Note

- This device supports xD M series card.
- This unit is able to recognize up to a maximum of 1,450 files per card.
- If it is not fully inserted, the "Memory Card" will not work. Some memory cards may not be performed correctly.
- If you remove the "Memory Card" during Memory Card operation, the recorded data may become corrupted. It is better to remove it after pressing DVD/CARD button to return to DVD/CD Mode.
- Memory Stick Duo, Mini SD, and RS-MMC must be inserted into a slot using adapter. But some Memory cards may not be performed correctly depending on the adapter condition.
- Please remove the "Memory Card" and adapter at the same time.
- DVD/CD cannot be played in the Memory Card mode. If you press the DVD/CARD or OPEN/CLOSE button in M.CARD mode, the system will automatically switch to the DVD/CD mode.
- When pressing the DVD/CARD button to play the disc again, the player doesn't remember where you stopped.
- It takes time to load files according to Memory Card Maker, file size and the number of files.

When playing a Memory Card

1

Insert a Memory Card.

2

Press the **DVD/CARD** button on the remote control.

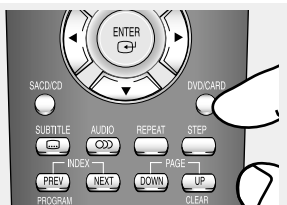

3

Depending on the file type stored on the Memory card, audio files will be played the same way as MP3 files and picture files will be played the same way as Picture CD's files. (See pages 48 to 54)

Advanced Functions

DVD AUDIO Playback

1

Open the disc tray.
Place the DVD AUDIO disc on the tray.
- Place the DVD AUDIO disc with the labeled side up.
Close the tray.
- The tray closes and disc plays.

2

During play, press the **DISPLAY** button on the remote control.

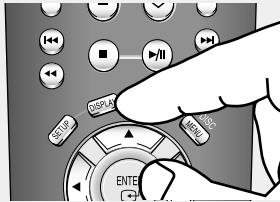

◀ You can select Info in the function menu by pressing the MENU button.

3

Press the ▲/▼ buttons to select the desired item.



◀ You may use the number buttons on the remote control to directly access a Group, Track, Page or to start the playback from the desired time.

4

Press the ◀▶ buttons to make the desired setup and then press the **ENTER** button.

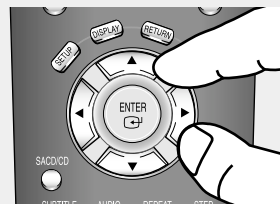

5



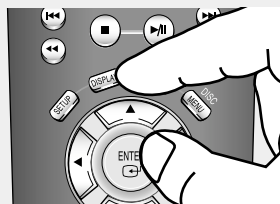



To make the screen disappear, press the **DISPLAY** button again.



◀ Some DVD-AUDIO discs don't down-mix audio. These discs always output 5.1ch analog audio regardless of audio setup.

Advanced Functions

Note

	Most DVD AUDIO discs are recorded in Groups. You can change Groups with this Function. Bonus Group playback. Some DVD AUDIO discs have Bonus groups. If you want to play a Bonus group, you must enter the Bonus Group code. The code is usually on the DVD AUDIO disc case.
	To access the desired Track when there is more than one on the DVD AUDIO disc.
	If pages are included on the DVD-AUDIO disc, you can see this icon. To access the desired page, you can use this Function.
	If a slide show is included on the DVD-AUDIO disc, you can see this icon. In this case, you cannot use PAGE DOWN/UP buttons.
	If a video zone is included on the DVD-AUDIO disc, you can see this icon. In this case, you cannot use PAGE DOWN/UP buttons.
	Allows playback of music from a desired time by using the number buttons.

Page / Index Function

1

Use **PAGE DOWN/UP** buttons to Skip the Page when there is more than one in a group.

- Some DVD-AUDIO discs include a slide show. In the slide show mode, this function cannot be used.
- PAGE is still images. You can see the still images when a DVD-AUDIO disc is played back.

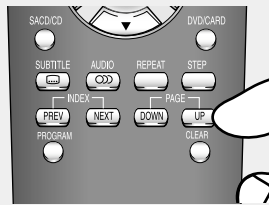

Note

Depending on a disc, this function may not work.

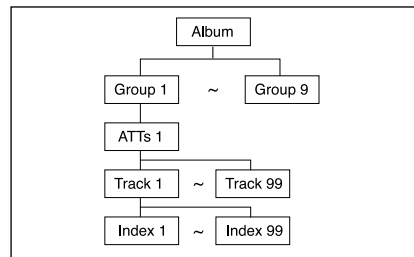

2

Use **INDEX PREV/NEXT** buttons to Skip the Index when there is more than one in a track.



Advanced Functions

REPEAT Play

1
Press the **REPEAT** button on the remote control. Repeat screen appears.



2
Press the ◀▶ buttons to select **Track** or **Group**, then press the **ENTER** button.

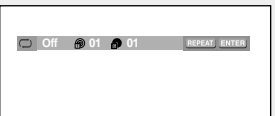

- ◀ Track (🎵): repeats the title that is playing.
- ▶ Group (📁): repeats the group that is playing.

AUDIO Format Display

1
During DVD AUDIO playback, press the **AUDIO** button to see AUDIO Format information.

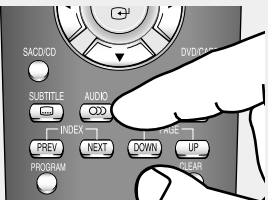
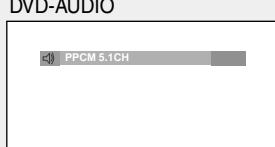
- ◀ - **LPCM** : Linear Pulse Code Modulation. Not compressed Audio data format.
- **PPCM** : Packet Pulse Code Modulation. Lossless compressed Audio data format.

Note
Some DVD-AUDIO discs don't allow audio down-mixing.

Advanced Functions

Advanced Functions

Super Audio CD Playback

1

- Open the disc tray.
Place the Super Audio CD disc on the tray.
- Place the Super Audio CD disc with the labelled side up.
Close the tray.
- The tray closes and you should get a screen.



Super Audio CD Clips Menu On Play Function

1

- Use the ▲/▼ buttons to select a music title.

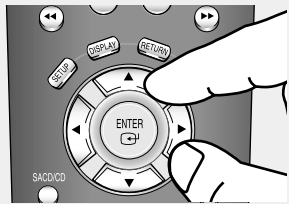

2

- Press the **ENTER** button to begin playback of the music title.

- If you want to use the Repeat Function, press the **REPEAT** button to change the mode, such as Off, Track, Disc.

* Off : Normal Playback

* Track : Repeats the current music title.

* Disc : Repeats the music titles in the Super Audio CD.

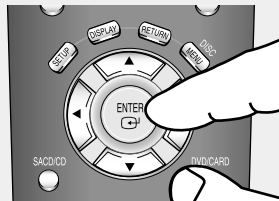

- ◀ If you want to see information about the Disc title and Artist, press the **DISPLAY** button.
If you want to convert to regular CD mode, press the **SACD/CD** button.
During play or stop mode, you can change the 2CH or MULTI mode by using ◀▶ buttons. (You can use this function when Super Audio CD disc includes both multi-channel and 2 channel audio format.)

Advanced Functions

Super Audio CD Clips Menu Off Play Function

1

In Stop mode, press the **DISC MENU** button until the Clips menu is off.

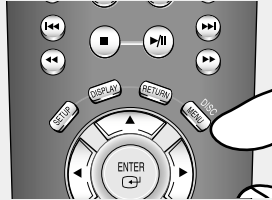

2

During play, press the **DISPLAY** button on the remote control.



◀ You can select Info in the function menu by pressing the **SETUP** button.

3

Press the **▲/▼** buttons to select the desired item.

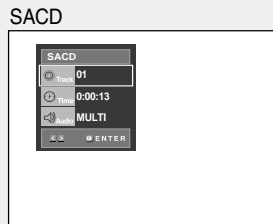

4

Press the **◀/▶** buttons to make the desired setup and then press the **ENTER** button.

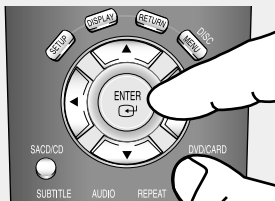

◀ You may use the number buttons on the remote control to directly access a track and to start the playback from the desired time.

5

To make the screen disappear, press the **DISPLAY** button again.



Advanced Functions

CD Layer Play Function

1



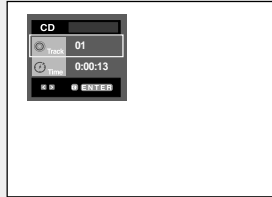

During Super Audio CD playback, press the **SACD/CD** button to playback the CD layer of a dual layer Super Audio CD disc. (Refer to the page 26 for setting CD playback Function).



Note

- Some Super Audio CD discs do not include a CD layer.
- Depending on a disc, this function may not work.
- Super Audio CD, SA-CD and their logos are trademarks of Sony and Philips.

Note

	(SACD) To access the desired Track when there is more than one in the disc.
	(SACD) Allows playback from a desired time by using the number buttons.
	(SACD) If you want to change the 2 channel or multi-channel mode in play or stop mode, press AUDIO button. - You can use this function when the Super Audio CD disc includes multi-channel and 2 channel audio format. • 2CH : L, R • MULTI : F/L, F/R, R/L, R/R, C/T, S/W
	(CD) To access the desired Track when there is more than one in the disc.
	(CD) Allows playback from a desired time. You must enter the starting time as a reference.

Advanced Functions







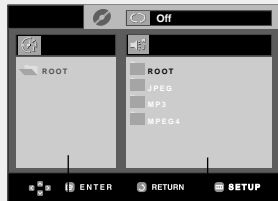

Clips Menu for MP3/JPEG/MPEG4

Discs with MP3/JPEG/MPEG4 contain individual songs and/or pictures that can be organized into folders as shown below. They are similar to how you use your computer to put files into different folders.

Open the disc tray.
Place the disc on the tray.
Close the tray.
The tray closes and this screen displays.



Parent Folder, Current Folder and Peer Folders
Folders and Files in Current Folder

-  : Current playing file name.
-  : MP3 file icon.
-  : Current Playback Time.
-  : JPEG file icon.
-  : Current Playback Mode : There are four modes. They can be selected in order by pressing the **REPEAT** button.
-  : AVI file icon.
-  : Folder icon.
-  : Current Folder icon.
- Off: Normal Playback
- Track: Repeats the current track.
- Folder: Repeats the current folder.
- Random: Files in the disc will be played in random order.

Folder Selection

The folder can only be selected in the Stop mode.

- **To select the Parent Folder**
Press the **RETURN** button to go to the parent folder, or press the **▲/▼** buttons to select “..” and press **ENTER** to go to the parent folder.
- **To select the Peer Folder**
Press the **◀/▶** buttons to highlight the left window. Press the **▲/▼** buttons to select the desired folder, then press **ENTER**.
- **To select the Sub-Folder**
Press the **◀/▶** buttons to highlight the right window. Press the **▲/▼** buttons to select the desired folder, then press **ENTER**.

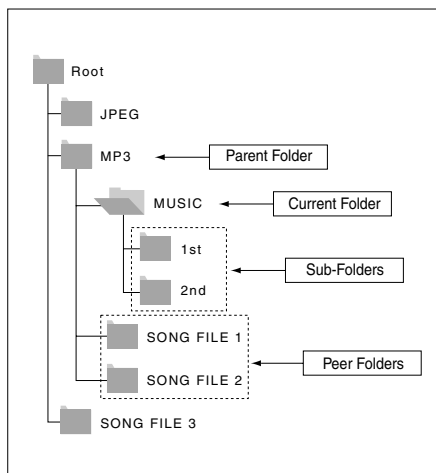

Advanced Functions

MP3 Playback

1

Open the disc tray.
Place the disc on the tray.
Close the tray.

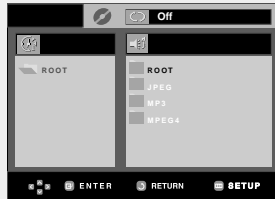

2

Press the ▲/▼ or ◀/▶ buttons to select a song file.
Press **ENTER** to begin playback of the song file.



Note

- Depending on the recording method, some MP3 CD-Rs may not be played.
- It is impossible to write MP3 or JPEG files to a Memory Card in this unit as it is read-only.
- Only MP3 Format files with the “.mp3” extensions can be played.

Repeat/Random playback

1

Press the **REPEAT** button to change the playback mode. There are four modes; **Off**, **Track**, **Folder** and **Random**.

- **Off**: Normal Playback
- **Track**: Repeats the current song file.
- **Folder**: Repeats the song files which have the same extension in the current folder.
- **Random**: Song files which have the same extension will be played in random order.



To resume normal play, press the **CLEAR** button.

Advanced Functions

MP3 file

When you record MP3 file on CD-R/Memory Card, please refer to the following.

- Your MP3 files should be ISO 9660 or JOLIET format.

ISO 9660 format and Joliet MP3 file are compatible with Microsoft's DOS and Windows, and with Apple's Mac. This format is the most widely used. Memory Card over 4GB use FAT32, which may not be compatible with this unit.

- When naming your MP3 file, do not exceed 8 characters, and enter ".mp3" as the file extension.

General name format : Title.mp3. When composing your title, make sure that you use 8 characters or less, have no spaces in the name, and avoid the use of special characters including: (.,/, \, =, +).

- Use a decompression transfer rate of at least 128 Kbps when recording MP3 files.

Sound quality with MP3 files basically depends on the rate of compression/decompression you choose. Getting CD audio sound requires an analog/digital sampling rate, that is conversion to MP3 format, of at least 128 Kbps and up to 160 Kbps. However, choosing higher rates, like 192 Kbps or more, only rarely give better sound quality. Conversely, files with decompression rates below 128 Kbps will not be played properly.

- Use a sampling rate of at least 32Khz and up to 48Khz. Conversely, files will not be played properly and may be skipped.

- Do not try recording copyright protected MP3 files.

Certain "secured" files are encrypted and code protected to prevent illegal copying. These files are of the following types: Windows Media™ (registered trade mark of Microsoft Inc) and SDMI™ (registered trade mark of The SDMI Foundation). You cannot copy such files.

- Important:

The above recommendations cannot be taken as a guarantee that the DVD player will play MP3 recordings, or as an assurance of sound quality. You should note that certain technologies and methods for MP3 file recording on CD-Rs prevent optimal playback of these files on your DVD player (degraded sound quality and in some cases, inability of the player to read the files).

- This unit can play a maximum of 3000 files and 300 folders per disc.

- This DVD player requires discs/recordings to meet certain technical standards in order to achieve optimal playback quality. Pre-recorded DVDs are automatically set to these standards. There are many different types of recordable disc formats (including CD-R containing MP3 file). Because this area of technology is still evolving, Toshiba cannot guarantee that all recordable discs will produce optimal playback quality. The technical criteria set forth in this owner's manual are meant only as a guide.

- Please be advised that you must obtain permission from the applicable copyright owners to download copyrighted content, including music files, in any format, including the MP3 format, prior to the downloading thereof. Toshiba has no right to grant and does not grant permission to download any copyrighted content.

Advanced Functions

MPEG4 Playback

MPEG4 Play Function

AVI files are used to contain the audio and video data.

Only AVI format files with the “.avi” extensions can be played.

1

Open the disc tray.
Place the disc on the tray.
Close the tray.

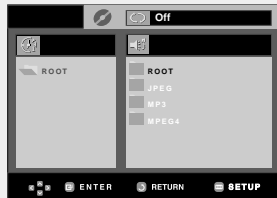

2

Press the ▲/▼ or ◀/▶ buttons to select an avi file (DivX/XviD), then press the **ENTER** button.

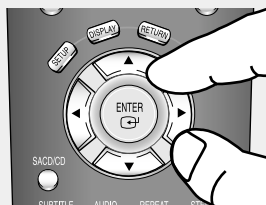

Repeat Playback

1

Press the **REPEAT** button to change playback mode. There are 4 modes, such as **Off**, **Folder**, **Title** and **A-B** (a distance between two points appointed by user).

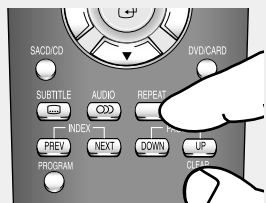

- Folder : Repeats the AVI files which have the same extension in the current folder.
- Title : repeats the title that is playing.
- A-B : repeats a segment of the file that you select.

Advanced Functions

MPEG4 Function Description

Function	Description	Reference page
Skip (◀◀ or ▶▶)	During play, press the ◀◀ or ▶▶ button, it moves forward or backward 5 minutes.	-
Search (◀◀ or ▶▶)	During play, press the SEARCH (◀◀ or ▶▶) button and press again to search at a faster speed. Allows you to search at a faster speed in an AVI file. (2X, 4X, 8X)	-
Slow Motion Play	Allows you to search at a slower speed in an AVI file. (1/8X, 1/4X, 1/2X)	P 24
Step Motion Play	Each time the STEP button is pressed, a new frame will appear.	P 24
ZOOM	2X/4X/2X/Normal in order	P 39

- These functions may not work depending on MPEG4 file.

CD-R AVI file

This unit can play the following video compression formats within the AVI file format:

- DivX 3.11 contents
- DivX 4 contents (Based on MPEG4 Simple Profile)
- DivX 5 contents (MPEG4 simple profile plus additional features such as bi-directional frames. Qpel and GMC are also supported.)

This unit supports all resolutions up to maximum below.

DivX3.11 & DivX4 & XviD	DivX5
Bitrate may fluctuate: Device may skip decoding the high bitrate portions and begin decoding again when Bitrate returns to normal.	720 x 480 @30fps 720 x 576 @25fps : Maximum bitrate : 4Mbps

Note

- Some MPEG4 files created on a personal computer may not be played properly. That is why Codec Type, Version and Higher resolution over specification is not supported.
- This unit supports CD-R/RW written in MPEG4 in accordance with the "ISO9660 format".
- This unit supports DivX Subtitle file formats such as .SMI, .SUB, .SRT, .SSA, .ASS, .PSB, and .TXT.

Advanced Functions

Picture CD Playback

1

Select the desired folder.

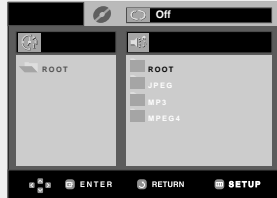

2

Press the ▲/▼ buttons to select a Picture file in the clips menu and then press the ENTER button.

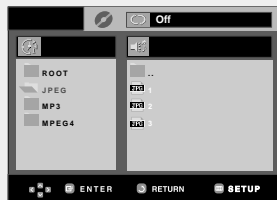

3

Press the DISPLAY button to display the menu. Press the ◀/▶ buttons to select the menu you want to view, then press the ENTER button.

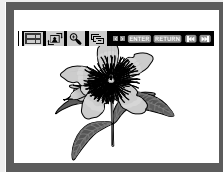

Note

- If no button on the remote control is pressed in about 10 seconds, the menu will disappear.
- Press the STOP button to return to the clips menu.
- When playing a Kodak Picture CD, the unit displays the Photo directly, not the clips menu.

Album Screen

- : Returns to the Album Screen.
- To see the next six pictures, press the ►► button.
- To see the previous six pictures, press the ◀◀ button.

Rotation

- : Each time the ENTER button is pressed, the picture rotates 90 degrees clockwise.

Zoom

- : Press the ▲/▼ or ◀/▶ buttons to select the part of the screen you want to zoom in on. Press the ENTER button. Each time the ENTER button is pressed, the picture is enlarged up to 4X. (2X → 4X → 2X → Normal)

Note

- Depending on a file size, the amount of time between each picture may be different from the set interval time.
- If you don't press any button, the slide show will start automatically in about 10 seconds by default.

Slide Show

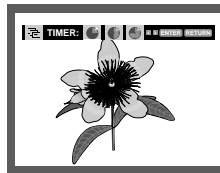

- : The unit enters slide show mode.
- Before the Slide Show begins, the picture interval must be set. Press the ◀/▶ buttons to select a desired icon, then press the ENTER button.
- : The pictures change automatically with about a 6 second interval.
- : The pictures change automatically with about a 12 second interval.
- : The pictures change automatically with about a 18 second interval.

Advanced Functions

Picture CD Playback for HD-JPEG

Must connect to HDMI. Resolution should be 720p or 1080i, and HD-JPEG should be in HD mode. (See page 64 to 66)

1

Set the HD-JPEG to HD from **Setup** menu.
(See page 64 to 66)

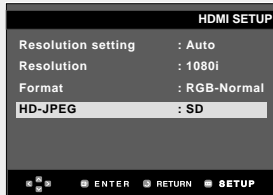

Note

- Only available in HDMI/COMPONENT(P-SCAN) output.

◀ To exit the setup menu, press the **SETUP** button.

2

Select the desired folder.

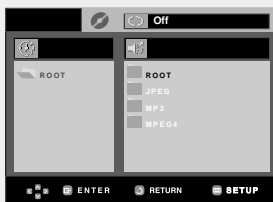

3

Press the **▲/▼** buttons to select a Picture file in the clips menu and then press the **ENTER** button.



◀ Press the **STOP (■)** button to return to the clips menu.

When playing a Kodak Picture CD, the unit displays the Photo directly, not the clips menu.

Skip Picture

Press the **◀◀** or **▶▶** button to select previous or next picture.



Slide Show

Press the the **PLAY/PAUSE (▶||)** button to start **SLIDE** function.

Press the the **PLAY/PAUSE (▶||)** button again at this time to stop **SLIDE** function.

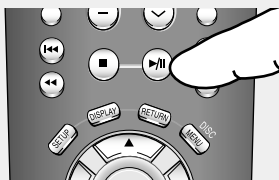

Note

- Depending on a file size, the amount of time between each picture may be different from the set interval time.
- Album Screen, Zoom, and Info functions are not available when displaying images in HD-JPEG mode.
- OSD (On Screen Display) messages are not displayed when displaying images in HD-JPEG mode.
- The image may be displayed at a smaller size depending on the picture size when displaying images in HD-JPEG mode.

Advanced Functions

JPEG Discs

When playing a CD-R/Memory Card/Picture CD

- Only files with the ".jpg" and ".JPG" extensions can be played.
- If the disc is not closed, it will take longer time to start play and not all of the recorded files may be played.
- Only CD-R discs with JPEG files in ISO 9660 or Joliet format can be played.
- Some memory cards may not be performed correctly.
- The name of the JPEG file may not be longer than 8 characters and should contain no blank spaces or special characters (. / = +).
- Only a consecutively written multi-session disc can be played. If there is a blank segment in the multi-session disc, the disc can be played only up to the blank segment.
- A maximum of 3000 images can be stored on a single CD.
- Kodak Picture CDs are recommended.
- When playing a Kodak Picture CD, only the JPEG files in the pictures folder can be played.
- Kodak Picture CD: The JPEG files in the pictures folder can be played automatically.
- Konica Picture CD: If you want to see the Picture, select the JPEG files in the clips menu.
- Fuji Picture CD: If you want to see the Picture, select the JPEG files in the clips menu.
- QSS Picture CD: The unit may not play QSS Picture CD.
- If the number of files in 1 Disc is over 3000, only 3000 JPEG files can be played.
- If the number of folders in 1 Disc is over 300, only JPEG files in 300 folders can be played.

Changing Setup Menu

Using the Setup Menu

The Setup menu lets you customize your DVD player by allowing you to select various language preferences, set up a parental level or even adjust the player to the type of television screen you have.

1

With the unit in Stop mode, press the **SETUP** button on the remote control. Press the **▲/▼** buttons to select **Setup**, then press the **▶** or **ENTER** button.



- ❶ Language Setup : Setup of the Language.
- ❷ Audio Setup : Setup of the Audio Options.
- ❸ Display Setup : Setup of the Display Options. Use to select which type of screen you want to watch and several display options.
- ❹ Parental Setup : Setup of the Parental Level. Allows users to set the level necessary to prevent children from viewing unsuitable movies such as those with violence, adult subject matter, etc.
- ❺ DivX(R) Registration : Please use the Registration code to register this player with the DivX(R) Video On Demand format. To learn more go to www.divx.com/vod.

2

Press the **▲/▼** buttons to access the different features. Press the **▶** or **ENTER** button to access the sub features.

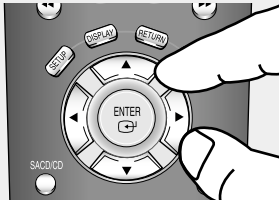

3

To make the setup screen disappear after setting up, press the **SETUP** button again.



Note

- Depending on the disc, some Setup menu selections may not work.

Changing Setup Menu

Setting Up the Language Features

If you set the player menu, disc menu, audio and subtitle language in advance, they will come up automatically every time you watch a movie.

Using the Player Menu Language

1

With the unit in Stop mode, press the **SETUP** button.

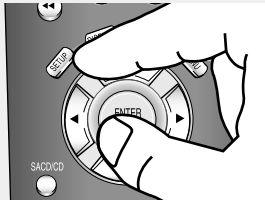

2

Press the ▲/▼ buttons to select **Setup**, then press the ► or **ENTER** button.



3

Press the ▲/▼ buttons to select **Language Setup**, then press the ► or **ENTER** button.



4

Press the ▲/▼ buttons to select **Player Menu**, then press the ► or **ENTER** button.



5

Press the ▲/▼ buttons to select the desired language, then press the ► or **ENTER** button.



- ◀ - The language is selected and the screen returns to Language Setup menu.
- To exit the setup menu, press the **SETUP** button.

Changing Setup Menu

Using the Disc Menu Language

This function changes the text language only on the disc menu screens.

1

With the unit in Stop mode, press the **SETUP** button.



2

Press the ▲/▼ buttons to select **Setup**, then press the ► or **ENTER** button.

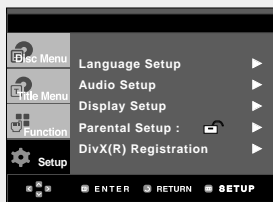

3

Press the ▲/▼ buttons to select **Language Setup**, then press the ► or **ENTER** button.

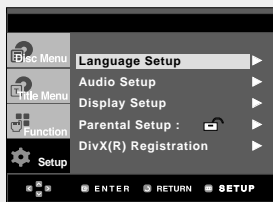

4

Press the ▲/▼ buttons to select **Disc Menu**, then press the ► or **ENTER** button.

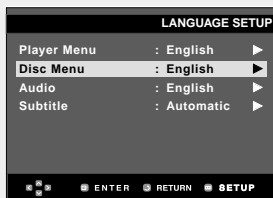

5

Press the ▲/▼ buttons to select the desired language, then press the ► or **ENTER** button.



- ◀ - Select "Others" if the language you want is not listed.
- If the selected language is not recorded on the disc, the original pre-recorded language is selected.
- The language is selected and the screen returns to Language Setup menu.
- To exit the setup menu, press the **SETUP** button.

Changing Setup Menu

Changing Setup Menu

Using the Audio Language

1

With the unit in Stop mode, press the **SETUP** button.



2

Press the ▲/▼ buttons to select **Setup**, then press the ► or **ENTER** button.

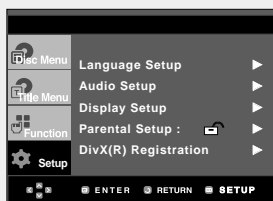

3

Press the ▲/▼ buttons to select **Language Setup**, then press the ► or **ENTER** button.

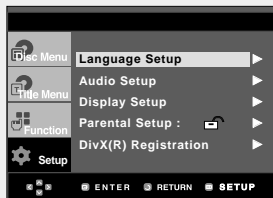

4

Press the ▲/▼ buttons to select **Audio**, then press the ► or **ENTER** button.



5

Press the ▲/▼ buttons to select the desired language, then press the ► or **ENTER** button.



- ◀ - Select "Original" if you want the default soundtrack language to be the original language the disc is recorded in.
- Select "Others" if the language you want is not listed.
- If the selected language is not recorded on the disc, the original pre-recorded language is selected.
- The language is selected and the screen returns to Language Setup menu.
- To exit the setup menu, press the **SETUP** button.

Changing Setup Menu

Using the Subtitle Language

1

With the unit in Stop mode, press the **SETUP** button.

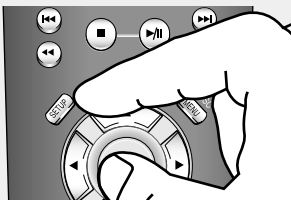

2

Press the ▲/▼ buttons to select **Setup**, then press the ► or **ENTER** button.

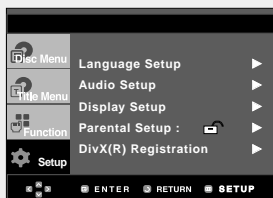

3

Press the ▲/▼ buttons to select **Language Setup**, then press the ► or **ENTER** button.

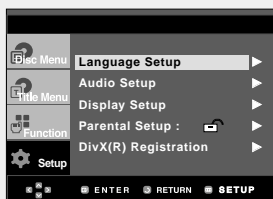

4

Press the ▲/▼ buttons to select **Subtitle**, then press the ► or **ENTER** button.



5

Press the ▲/▼ buttons to select the desired language, then press the ► or **ENTER** button.

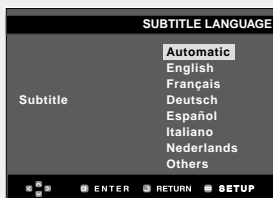

- ◀ - Select "Automatic" if you want the subtitle language to be the same as the language selected as the audio language.
- Select "Others" if the language you want is not listed. Some discs may not contain the language you select as your initial language; in that case the disc will use its original language setting.
- The language is selected and the screen returns to setup menu.
- To exit the setup menu, press the **SETUP** button.

Changing Setup Menu

Setting Up the Audio Options

Audio Options allows you to setup the audio device and sound status settings depending on the audio system in use.

1

With the unit in Stop mode, press the **SETUP** button.

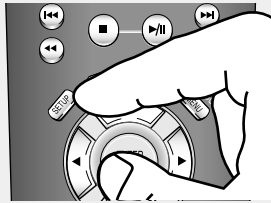

2

Press the **▲/▼** buttons to select **Setup**, then press the **▶** or **ENTER** button.



3

Press the **▲/▼** buttons to select **Audio Setup**, then press the **▶** or **ENTER** button.

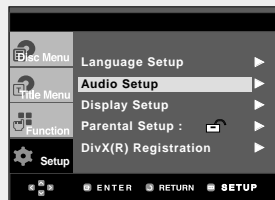

4

Press the **▲/▼** buttons to select the desired item, then press the **▶** or **ENTER** button.

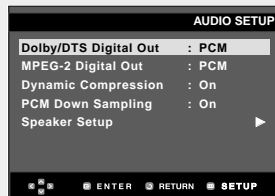

◀ To exit the setup menu, press the **SETUP** button.

Changing Setup Menu

- ❶ **Dolby/DTS Digital Out**
 - PCM : Converts to PCM(2CH) audio.
 - Bitstream : Outputs Dolby Digital or DTS Bitstream via digital output.
Select Bitstream when connecting to a Dolby Digital and DTS Decoder.
- ❷ **MPEG-2 Digital Out**
 - PCM : Converts to PCM(2CH) audio. Select PCM when using the Analog Audio Outputs.
 - Bitstream : Converts to MPEG-2 Digital Bitstream (5.1CH or 7.1CH).
Select Bitstream when using the Digital Audio Output.
- ❸ **Dynamic Compression**
 - On : To select dynamic compression.
 - Off : To select the standard range.
- ❹ **PCM Down Sampling**
 - On : Select this when the Amplifier connected to the player is not 96KHz compatible.
In this case, the 96KHz signals will be down converted to 48KHZ.
 - Off : Select this when the Amplifier connected to the player is 96KHz compatible.
In this case, all signals will be output without any changes.

Note

Even when PCM Down Sampling is Off

- Some discs will only output down sampled audio through the digital outputs.

❺ Speaker Setup (See pages 62~63)

HDMI

- **If your TV is not compatible with compressed multi-channel formats (Dolby Digital or DTS), you should set Digital Audio to PCM.**
- **If your TV is not compatible with LPCM sampling rates over 48kHz, you should set PCM Down Sampling to On.**
- **SACD audio is only available through the analog outputs. It is not possible to output SACD audio via the HDMI output or Digital Audio Output.**

Note

- To exit the setup menu, press the SETUP button.
- DVD-AUDIO
 - Outputs 2 channel digital audio only.
 - Some DVD-AUDIO discs do not down-mix, so they will not output 2 channel digital audio.
 - MULTI channel DVD-AUDIO discs playback through the analog outputs.
- Super Audio CD
 - Outputs analog signals only.
 - Super Audio CD audio is only available through the analog outputs.
It is not possible to output Super Audio CD audio via the HDMI output or Digital Audio Output.

Manufactured under license from Dolby Laboratories. "Dolby" and the double-D symbol are trademarks of Dolby Laboratories.

"DTS" and "DTS Digital Out" are trademarks of Digital Theater Systems, Inc.

Changing Setup Menu

Surround Sound Speaker Setup

1

With the unit in Stop mode, press the **SETUP** button.

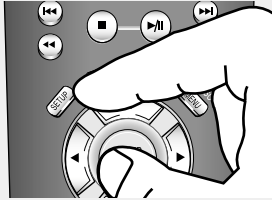

2

Press the **▲/▼** buttons to select **Setup**, then press the **▶** or **ENTER** button.



3

Press the **▲/▼** buttons to select **Audio Setup**, then press the **▶** or **ENTER** button.



4

Press the **▲/▼** buttons to select **Speaker Setup**, then press the **▶** or **ENTER** button.

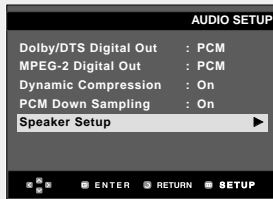

5

Press the **▲/▼/◀/▶** buttons to select the desired item, then press the **ENTER** button to set the speaker.

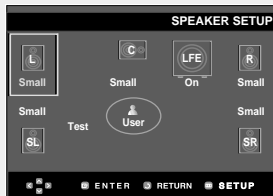

◀ To exit the setup menu, press the **SETUP** button.

Changing Setup Menu

The default settings : FRONT L, R (Small), CENTER (Small), SURROUND SL, SR (Small).
Select the size of the speakers to be connected.

❶ Front (FL, FR)

- Large: Normally select this.
- Small: When the sound distorts or the surround sound effects are difficult to hear, select this.
This activates the Dolby Digital bass redirection circuitry and outputs the bass frequencies of the speaker from the subwoofer.

❷ Center

- None: If you do not connect a center speaker, select this.
- Large: Normally select this.
- Small: When the sound distorts, select this.
This activates the Dolby Digital bass redirection circuitry and outputs the bass frequencies of the center speaker from other speakers.

❸ Surround (SL, SR)

- None: If you do not connect a center speaker, select this.
- Large (Rear/Side): Normally select either of these according to the rear speaker's position.
- Small (Rear/Side): When the sound distorts or the surround sound effects are difficult to hear, select either of these according to the rear speaker's position.
This activates the Dolby Digital bass redirection circuitry and outputs the bass frequencies of the rear speaker from other speakers.

Setting up Test

The test output signals come clockwise starting from the Front Speaker(L).

Adjust Channel Balance so that speakers output equally in your room.

FRONT(L) → CENTER → SUBWOOFER → FRONT(R) → SURROUND(R) → SURROUND(L)

Note

To make the Setup menu disappear or return to menu screen during set up, press RETURN or ◀ button.

- The subwoofer test output signal is lower than the other speakers.
- The MPEG Multi-channel logo is a trademark registered by PHILIPS Corporation.
- If you set Front (L, R) "Small", LFE (Subwoofer) is set "On" automatically.

Changing Setup Menu

Setting Up the Display Options

Display options enable you to set various video functions of the player.

1

With the unit in Stop mode, press the **SETUP** button.



2

Press the ▲/▼ buttons to select **Setup**, then press the ► or **ENTER** button.



3

Press the ▲/▼ buttons to select **Display Setup**, then press the ► or **ENTER** button.

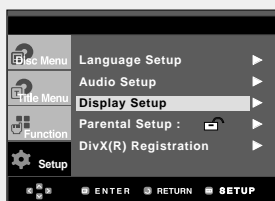

4

Press the ▲/▼ buttons to select the desired item, then press the ► or **ENTER** button.

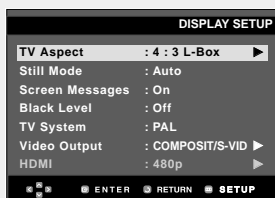

◀ To exit the setup menu, press the **SETUP** button.

Changing Setup Menu

1 TV Aspect

Depending on the type of television you have, you may want to adjust the screen setting (aspect ratio).

- 4:3 Letter Box : Select when you want to see the total 16:9 ratio screen DVD supplies, even though you have a TV with a 4:3 ratio screen. Black bars will appear at the top and bottom of the screen.
- 4:3 Pan & Scan : Select this for conventional size TVs when you want to see the central portion of the 16:9 screen. (Extreme left and right side of movie picture will be cut off.)
- 16:9 Wide : You can view the full 16:9 picture on your wide screen TV.

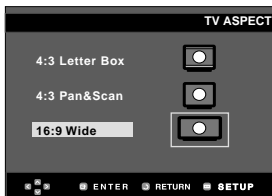

2 Still Mode

These options will help prevent picture shake in still mode and display small text clearer.

- Auto : When selecting Auto, Field/Frame mode will be automatically converted.
- Field : Select this feature when the screen shakes in the Auto mode.
- Frame : Select this feature when you want to see small letters more clearly in the Auto mode.

3 Screen Messages

Use to turn on-screen messages On or Off.

4 Black Level

Adjusts the brightness of the screen.(On or Off) It does not function in Progressive mode.

5 TV System

1. NTSC Disc : In case of using NTSC disc
 - If your TV system only has PAL-Video input, you must choose "PAL". When you choose "PAL", Interlace output format is PAL 60 Hz output or Component (I-Scan) 480i.
 - If your TV system only has NTSC input, you must choose "NTSC Output".

2. PAL Disc : In case of using PAL disc
 - If your TV system only has NTSC-Video input, you must choose "NTSC Output".
 - If your TV system only has PAL input, you must choose "PAL Output".

6 Video Output

Select Video Output.

- COMPOSITE/S-VIDEO : Select when you want to use Video and S-Video Out.
- COMPONENT(I-SCAN) : Select when you want to use Video and Component 525i(480i)/625i(576i) (Interlace) Out.
- HDMI/COMPONENT(P-SCAN) : Select when you want to use Component 525p(480p)/625p(576p) (Progressive) Out or HDMI.

- If the Yes/No selection in the Display Setup sub Menu is not made within 10 seconds, the screen returns to the previous menu.
- Video Output mode can also be changed in the following sequence in no disc mode by pressing the V.OUT button.

▶ COMPOSITE/S-VIDEO → COMPONENT(I-SCAN) → HDMI/COMPONENT(P-SCAN) ◀

If HDMI/COMPONENT(P-SCAN) mode is selected and your TV does not support HDMI or progressive scan, you cannot see any picture. Press the V.OUT button until the picture can be seen on the screen.

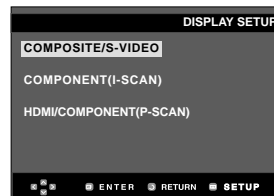
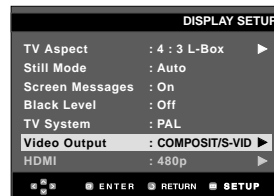

Changing Setup Menu

⑥ HDMI

This setting can only be used when the unit is connected by HDMI to Display devices (TV, Projector, etc.), otherwise the HDMI setting cannot be selected.

- Resolution setting
 - Auto : Resolution setting automatically
 - Manual : Resolution setting manually
- Resolution
 - 480p/576p : 720X480, 720X576
 - 720p : 1280 x 720
 - 1080i : 1920 x 1080
- Format

You can use this function to set HDMI output's digital data RGB range.

- RGB-Normal : HDMI Limited range RGB data output.
- RGB-Expand : HDMI Full range RGB data output.
- YCbCr-(4:4:4) : HDMI Limited range YCbCr-(4:4:4) output.
- YCbCr-(4:2:2) : HDMI Limited range YCbCr-(4:2:2) output.

Limited range - Black/White and colour level displayed within Limited data range.

When the bit depth is 8 bits

- Y : 16~235 - levels of brightness
- CbCr : 16~240 - levels of colour

Full range - Black/White and colour level are expressed within full data range.

When the bit depth is 8 bits

- Y : 0~255 - levels of brightness
- CbCr : 0~255 - levels of colour

- HD-JPEG

- HD : High Definition image source
 - Available when resolution is 720p or 1080i in HDMI enabled.
- SD : Standard Definition image source

- **Consult your TV User's Manual to find out if your TV supports Progressive Scan. If Progressive Scan is supported, follow the TV User's Manual regarding Progressive Scan settings in the TV's menu system.**
- **If Video Output is set incorrectly, the screen may be blocked.**
- **The resolutions available for HDMI output depend on the connected TV or projector. For details, see the user's manual of your TV or projector.**
- **When the resolution is changed during playback, it may take a few seconds for a normal image to appear.**
- **If you set the HDMI output resolution 720p or 1080i, HDMI output provides better picture quality.**
- **No sound will be output from the HDMI cable if the Dolby/DTS Digital Out is not set to PCM.**

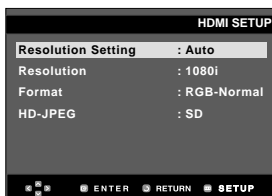

Changing Setup Menu

Setting Up the Parental Control

The Parental Control function works in conjunction with DVDs that have been assigned a rating, which helps you control the types of DVDs that your family watches. There are up to 8 rating levels on a disc.

1

With the unit in Stop mode, press the **SETUP** button.

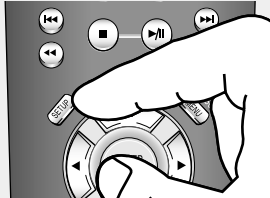

2

Press the **▲/▼** buttons to select **Setup**, then press the **▶** or **ENTER** button.

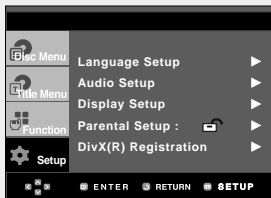

3

Press the **▲/▼** buttons to select **Parental Setup**, then press the **▶** or **ENTER** button.

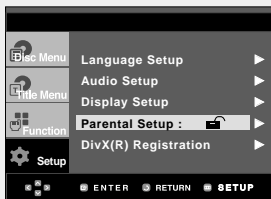

4

Press the **▶** or **ENTER** button to select **Yes** if you want to use a password. The Enter Password screen appears.

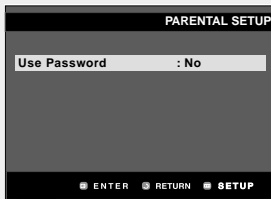

5

Enter your password. The Re-enter Password screen appears to confirm the password. Enter your password again. The player is locked (🔒).

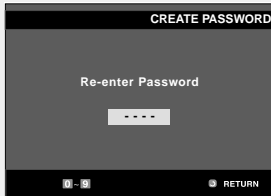
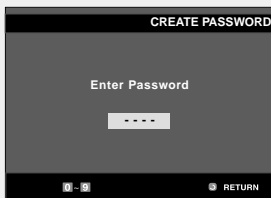

◀ To exit the setup menu, press the **SETUP** button.

Changing Setup Menu

Setting Up the Rating Level

1

With the unit in Stop mode, press the **SETUP** button. Press the **▲/▼** buttons to select **Setup**, then press the **▶** or **ENTER** button.

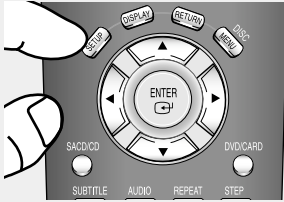

2

Press the **▲/▼** buttons to select **Parental Setup**, then press the **▶** or **ENTER** button.



3

Enter your password.



4

Press the **▲/▼** buttons to select **Rating Level**, then press the **▶** or **ENTER** button.

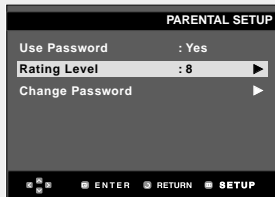

5

Press the **▲/▼** buttons to select the Rating Level you want, then press the **▶** or **ENTER** button. e.g.) Setting up in **Level 6**.



6

Press the **OPEN/CLOSE** to activate Parental control setting.



◀ To exit the setup menu, press the **SETUP** button.

For example, if you select up to Level 6, discs that contain Level 7 and 8 will not play.

◀ If the DVD disc has been designed to temporarily cancel the Rating Level, the screen which follows the "PLAY" screen will change depending on which disc is played. If you select "Yes" with the **ENTER** button, "Enter Password" screen will appear. Input the 4-digit password as you have set at step 4 page 67 and playback will start. If "No" is selected, press the **OPEN/CLOSE** to remove the disc.

Changing Setup Menu

Changing the Password

1

With the unit in Stop mode, press the **SETUP** button.

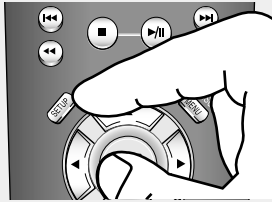

2

Press the ▲/▼ buttons to select **Setup**, then press the ► or **ENTER** button.

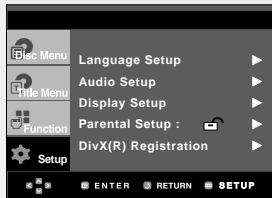

3

Press the ▲/▼ buttons to select **Parental Setup**, then press the ► or **ENTER** button. The Enter Password screen appears. Enter your password.



4

Press the ▲/▼ button to select **Change Password**, then press the ► or **ENTER** button. Enter your new password. Re-enter the new password again.

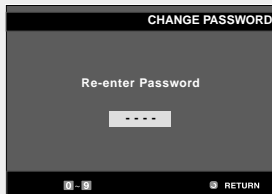
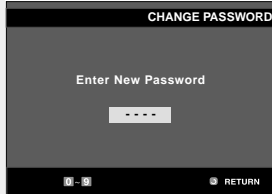
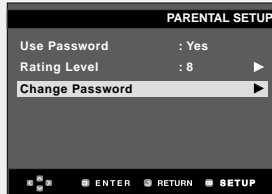

◀ To exit the setup menu, press the **SETUP** button.

Changing Setup Menu

Note

If you have forgotten your password, see "Forgot Password" in the Troubleshooting on page 72.

Reference

Controlling a TV with the Remote Control

The remote control can be compatible with various brands of TV by setting their control codes. The TOSHIBA code has initially been set to control TOSHIBA TVs.

Setting Control Codes

1. Press **TV** to set the remote control operating your TV.
2. While holding down **PROGRAM** button, enter the four digits of your TV's brand code (listed right) using number buttons.
3. Release **PROGRAM**.
4. Point the remote control at your TV and use each button listed below to make sure your TV is operated correctly.

ON/STANDBY

To turn the TV on or off.

CH

To select TV channels in the upper or lower direction.

VOL

To adjust the sound level.

INPUT

To select an external source such as a VCR.

DISPLAY

To turn on or off TV's screen display.

ENTER

To use for the TV's ENTER key.

Reference

Table of Brand Codes

Brand name	Brand code
TOSHIBA	0001 0071 0211 0571
AIWA	0921
AKAI	0201 0241 0311 0431 0501 0521 0641
BAIRD	0171 0241
BANG & OLUFSEN	0471
BEKO	0181
BLAUPUNKT	0071 0321 0331
BRIONVEGA	0461 0471 0651
BUSH 0071	0501 0551 0571
CROWN	0111 0131 0411 0491 0501 0661
DANSAI	0501
DEAWOO	0401 0411 0501
DECCA	0091 0141 0171 0441 0451 0501
FERGUSON	0031 0071 0131 0191 0291 0311 0381 0541 0601
FINLUX	0021 0041 0071 0081 0091 0111 0271 0281 0291 0301 0341 0471
FISHER	0041 0121 0181 0201 0281 0471 0571 0651
FUNAI	0001 0191 0481 0491 0891
GEC	0171 0221
GOLDSTAR	0201 0251 0281 0411 0501
GOODMANS	0171 0281 0501 0571
GRANADA	0171 0241 0271 0501 0571 0651 0671
GRUNDIG	0011 0071 0271 0321 0331
HINARI	0241 0411 0571 0631
HITACHI	0021 0221 0251 0351 0371 0381 0431 0571 0641 0751
INNO HIT	0171 0281 0411 0501 0631 0661
ITT	0231 0241 0261 0271 0401 0611
ITT-NOKIA	0231 0241 0261 0271 0401 0611
JVC	0311 0431 0521 0571
LOEWE OPTA	0471 0501 0571 0651
LUXOR	0241 0261 0271 0281 0351
MAGNAVOX	0501 0071 0191 0221 0461 0471 0591 0611 0651
MARANTZ	0201 0501
MATSUI	0001 0171 0191 0231 0411 0441 0451 0501 0551 0571
METZ	0041 0331 0361 0461 0471 0651
mitsubishi	0201 0321 0331 0451 0501 0511 0571 0651 0771
NATIONAL	0371 0501 0511 0531 0761 0841 0911 1061
NOKIA	0231 0241 0261 0271 0401 0611
NORDMENDE	0281 0351 0381 0421 0431 0461 0521 0541 0641 0671
OCEANIC	0481

Brand name	Brand code
ORION	0001 0191 0231 0361 0411 0441 0451 0501 0551 0611
PANASONIC	0371 0501 0511 0531 0761 0841 0911 1061
PHILCO	0071 0111 0181 0201 0271 0301 0461 0501 0651
PHILIPS	0071 0191 0221 0461 0471 0501 0591 0611 0651
PIONEER	0381 0431 0501 0831 1051
PROSCAN-THOMSON	0971 1041 0201 0501
RCA	0971 1071 1081 1091 0201 1041 0501 0631 1001 1011 1021 1031 0851 0201
REALISTIC	0501 0481 0321 0331 0501 0651 0771
SABA	0281 0351 0381 0421 0431 0471 0541 0641 0651 0661 0671
SAISHO	0231 0411 0441 0451 0551
SALORA	0231 0241 0351
SAMSUNG	0171 0181 0251 0281 0411 0491 0501 0631 0661 0791 1101 1111
SANYO	0021 0041 0081 0121 0171 0181 0201 0231 0241 0451 0571 0651 0671 0701 0711 0721
SCHNEIDER	0011 0051 0061 0281 0461 0501 0581 0591
SEG	0091 0121 0151
SELECO	0031 0051 0061 0351 0501 0561
SHARP	0851 0511 0571 0201 0501
SIEMENS	0071 0321 0331 0571 0631
SINGER	0091 0471 0651
SINUDYNE	0001 0091 0101 0131 0191 0231 0361 0471 0501 0551 0581 0651
SONY	0441 0451 0571 0681
TANDBERG	0041 0301 0351 0431 0461 0571 0651
TATUNG	0091 0141 0171 0441 0451 0501
TECHNICS	0371 0501 0511 0531 0761 0841 0911 1061
TELEFUNKEN	0071 0281 0381 0421 0431 0521 0601 0621 0671
TENSAI	0041
THOMSON	0281 0351 0371 0381 0391 0421 0461 0521 0541 0641 0971 1041
THORN	0041 0071 0281 0291 0341 0421 0491 0601 0671
UNIVERSUM	0021 0491
YAMAHA	0201 0501 0321 0331 0451 0511 0571 0651 0771
ZANUSSI	0031 0051 0061 0351 0501 0561
ZENITH	0931



Note

- Some TV's may not respond to all the operations above, or may not be operated at all with this remote control. In this case, operate your TV with its own remote control.
- For some brands, several control codes (brand codes) are allocated. Try each of them until the buttons work on your TV.
- If you replace the remote control's batteries, set the brand code again.

Reference

Troubleshooting

Before requesting service (troubleshooting), please check the following.

Problem	Action	Page
No operations can be performed with the remote control.	<ul style="list-style-type: none"> Check the batteries in the remote control. They may need replacing. Operate the remote control at a distance of not more than 20 feet. Remove batteries and hold down one or more buttons for several minutes to drain the microprocessor inside the remote control to reset it. Re-install batteries and try to operate the remote control again. 	P6
Disc does not play.	<ul style="list-style-type: none"> Ensure that the disc is installed with the label side facing up. Check the region number of the DVD. 	P10, 23
5.1 channel sound is not being reproduced.	<ul style="list-style-type: none"> 5.1 channel sound is reproduced only when the following conditions are met. : <ol style="list-style-type: none"> The DVD player is connected with the proper Amplifier. The disc is recorded with 5.1 channel sound. Check whether the disc being played has the "5.1 ch" marked on the outside. Check if your audio system is connected and worked properly. In a SETUP Menu, is the Audio Output set to Bitstream? 	P22 P60-61
The  icon appears on screen.	<ul style="list-style-type: none"> The features or action cannot be completed at this time because: <ol style="list-style-type: none"> The DVD's software restricts it. The DVD's software doesn't support the feature (e.g., angles). The feature is not available at the moment. You've requested a title or chapter number or search time that is out of range. 	-
Disc Menu doesn't appear.	<ul style="list-style-type: none"> Check if the disc has a Menu. 	-
Play mode differs from the Setup Menu selection.	<ul style="list-style-type: none"> Some of the functions selected in the Setup Menu may not work properly if the disc is not encoded with the corresponding function. 	P55-69
The screen ratio cannot be changed.	<ul style="list-style-type: none"> The Screen Ratio is fixed on your DVDs. 	P64-65
No audio.	<ul style="list-style-type: none"> Make sure you have selected the correct Digital Output in the Audio Options Menu. 	P60-63
The screen is blocked.	<ul style="list-style-type: none"> Press the  button for more than 5 seconds under no disc inside. All settings will revert to the factory settings. 	P23, 66
Forgot password.	<ul style="list-style-type: none"> Press and hold the  button for more than 5 seconds under no disc inside. All settings including the password will revert to the factory settings. Don't use this unless absolutely necessary. 	P67-69
If you experience other problems.	<ul style="list-style-type: none"> Go to the contents and find the section of the instruction book that contains the explanations regarding the current problem, and follow the procedure once again. If the problem still cannot be solved, please contact your nearest authorized service center. 	-
The picture is noisy or distorted.	<ul style="list-style-type: none"> Make sure that the disc is not dirty or scratched. Clean the disc. 	P9
No picture or abnormal colour (pinkish, greenish etc.)	<ul style="list-style-type: none"> Make sure the correct video output setting is selected in this unit. Make sure the video outputs are connected correctly. 	P65 P14-18

Reference

Problem	Action	Page
No HDMI output.	<ul style="list-style-type: none"> • Check the Video output is HDMI enabled. • Check the connection between the TV and the HDMI jack of DVD player. • See if the TV supports this 480p/720p/1080i DVD player. 	P18-19, P66
Abnormal HDMI output screen.	<ul style="list-style-type: none"> • If snow noise appears on the screen, it means that TV does not support HDCP (High-bandwidth Digital Content Protection). 	P18-19
HDMI output jitters.	<ul style="list-style-type: none"> • Check your TV system setup. • If the screen jitters, phenomenon may occur when frame rate is converted from 50Hz to 60Hz for 720P/1080i HDMI (High Definition Multimedia Interface) Output. • Please refer to the user's manual of your TV. 	P64-66
No Component video outputs in JPEG playback.	<ul style="list-style-type: none"> • Select SD in HDMI menu if you need to view both HDMI and component out in parallel. 	P66

Reference

Specifications

General	Power Requirements	AC 110-240V 60/50Hz
	Power Consumption	14 W
	Weight	5.1 lbs
	Dimensions	16.9 (W) x 9.8 (D) x 1.9 (H) inches
	Operating Temperature Range	+41°F to +95°F
	Operating Humidity Range	10 % to 75 %
Disc	DVD (DIGITAL VERSATILE DISC)	Reading Speed : 3.49 ~ 4.06 m/sec. Approx. Play Time (Single Sided, Single Layer Disc) : 135 min.
	CD : 3 1/2" (COMPACT DISC)	Reading Speed : 4.8 ~ 5.6 m/sec. Maximum Play Time : 74 min.
	CD : 8Cm (COMPACT DISC)	Reading Speed : 4.8 ~ 5.6 m/sec. Maximum Play Time : 20 min.
	VCD : 3 1/2"	Reading Speed : 4.8 ~ 5.6 m/sec. Maximum Play Time : 74 min. (Video + Audio)
Video Output	Composite Video	1 channel : 1.0 Vp-p (75 Ω load) Y : 1.0 Vp-p (75 Ω load)
	Component Video	Pr : 0.70 Vp-p (75 Ω load) Pb : 0.70 Vp-p (75 Ω load)
	S-Video	Luminance Signal : 1.0 Vp-p (75 Ω load) Chrominance Signal : 0.3 Vp-p (75 Ω load)
	HDMI	576p, 720p, 1080i
Audio Output	2 Channel	L(1/L), R(2/R)
	5.1 Channel	F/L, F/R, R/L, R/R, C/T, S/W
	Digital Audio Output	Optical/Coaxial
	*Frequency Response	48 kHz Sampling : 4 Hz to 22 kHz 96 kHz Sampling : 4 Hz to 44 kHz
	*S/N Ratio	110 dB
	*Dynamic Range	100 dB
	*Total Harmonic Distortion	0.004 %

*: Nominal specification

- Designs and specifications are subject to change without notice.
- This model complies with the above specifications.
- This model may not be compatible with features and/or specifications that may be added in the future.

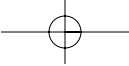

Memo

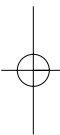
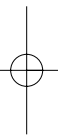

Reference

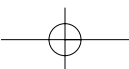

TOSHIBA

SmartMedia is a trademark of Toshiba Corp.
Toshiba is an authorized licensee of the Compact Flash® registered trademark.
SD is a trademark of SD Card Association.
MMC and MultiMedia Card are trademarks of Infineon Technologies AG and licensed to MMCA (MultiMediaCard Association).
Memory Stick is a trademark of Sony Corporation.